

R407C

ECO COOLER

AIR COOLED CHILLER

STANDARD MODEL

50Hz

150 kW – 2000 kW

WITH ECONOMIZER

2022

ECO COOLER
AIR CONDITIONER

MULTI STAGE EVAPORATIVE COOLING





Special Public places
Commercial, Office, Hospital, Restaurant,
Coffee shop & Etc .

ECO COOLER

AIR CONDITIONER

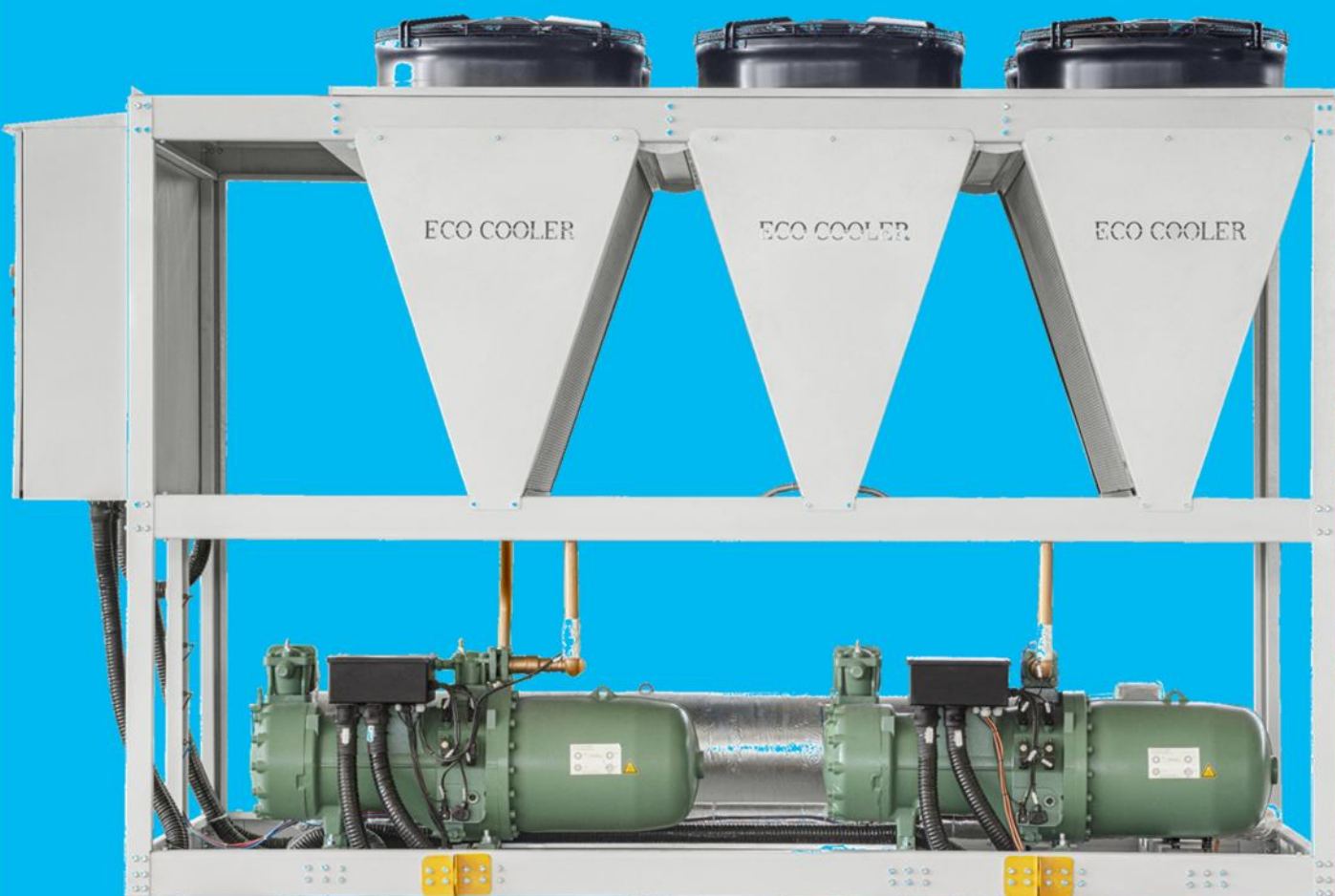



ECO COOLER

Table of Contents

INTRODUCTION	7
NOMENCLATURE	7
FEATURES AND BENEFITS	8
STANDARD SPECIFICATIONS	9
OPTIONAL FEATURES	15
TECHNICAL DATA	16
PERFORMANCE DATA TABLES	19
UNIT DIMENSIONS	24
Typical electrical wiring diagram	36
TYPICAL WIRING DIAGRAM	37

INTRODUCTION

Eco Cooler connection with customer is permanent and does not lead to sell units. Our motto is making the best environment for people to build a better world to live.

Eco Cooler Air cooled water chillers **EACH** series designed to be suitable for all weather conditions, from cold to moderate to hot climates, the various environment, from residential building to industrial sites with polluted environment. Optimum performance, high efficiency, low power consumption, easy installation and low noise operations are the features of the EACH chillers.

EACH series cooling capacities are available from 45 TR (158 kW) to 430 TR (1512 kW). Models are in two categories of STANDARD (for cold and moderate climates) and HIGH EFFICIENT (for hot and tropical climates) conditions.

NOMENCLATURE

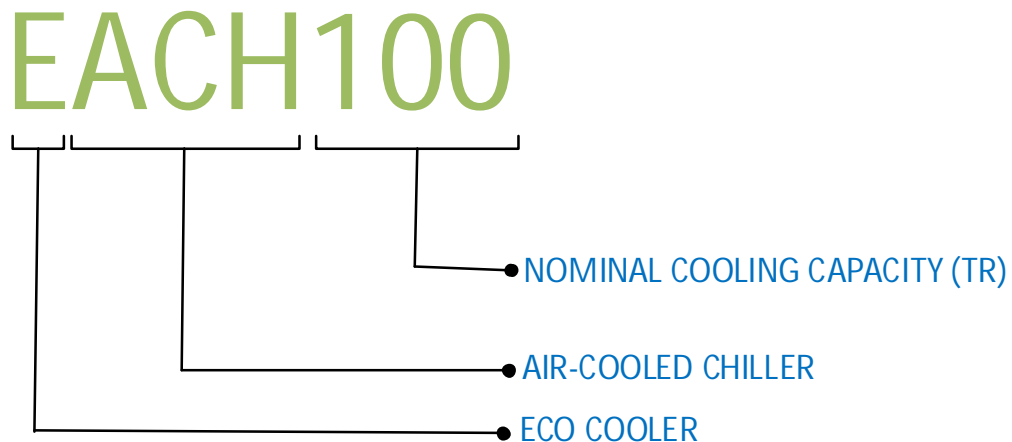

FEATURES AND BENEFITS

- Optimized energy efficiency both at full and part load conditions
- Low operating sound levels are achieved by the latest compressor and fan design
- Stepped and Stepless screw compressor with professional control system to minimize energy consumption and optimize the unit performance.
- Compact design for minimized installation space and small footprint
- One, two, three or four truly independent refrigerant circuits for outstanding reliability
- Using microchannel technology for condenser with higher corrosion resistance and longer life and 30% refrigerant charge compared to traditional solutions.
- Structure and base in hot-dip galvanized steel with electrostatic powder painting.
- Electrical expansion valve: quickly and precisely adapts to the effective load required.
- Connectable to Building Management Systems (BMS) via MODBUS, BACNet and CANBUS protocols.



STANDARD SPECIFICATIONS

SEMI HERMETIC SCREW COMPRESSOR

EACH compressors features mechanical capacity control, which enables very good efficiency and simple system integration. It features mechanical capacity control, which enables very good efficiency and simple system integration. Screw Compressors are equipped to solenoid valve for stepped or stepless capacity control, suction and discharge shut-off valve, oil sight glass, check valve in discharge gas outlet, oil fill/drain service valve, directly flanged on three stage oil separator, robust axial bearings in tandem configuration, internal pressure relief valve as a burst protection and manual lock-out electronic protection system for thermal motor winding temperature, phase reversal, discharge gas temperature protection controls.

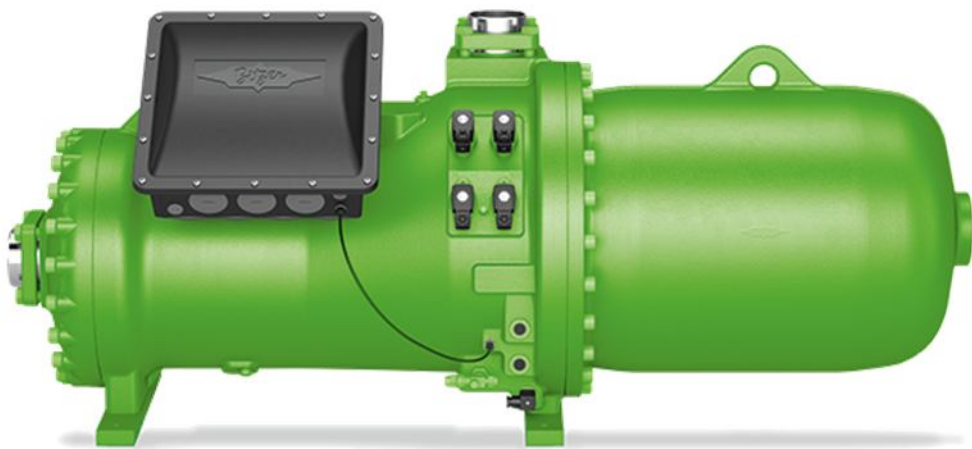

STANDARD SPECIFICATIONS

SHELL AND TUBE EVAPORATOR

The evaporator is a high efficiency DX shell & tube heat exchanger design with inner grooved copper tubes roller expanded into the tube sheet. evaporators are tested with a refrigerant side of 30 bars and a water side of 10 bars. Helium leak test is a standard test for evaporators. A guarantee is offered against coolant leak for up to 2 gr/year. Tests are performed at various pressure levels for multi circuit evaporator and prevention of leakage between circuits is guaranteed. Water connections are grooved pipe. Each shell includes a vent, a drain and fittings for temperature control sensors and is insulated with 3/4 inch equal insulation. Evaporator heaters with thermostat are provided to help protect the evaporator from freezing at ambient temperatures down to -29°C.

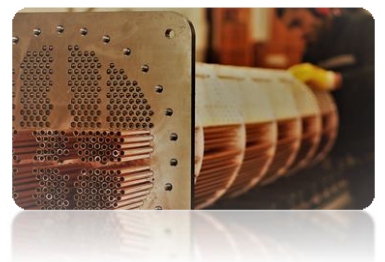
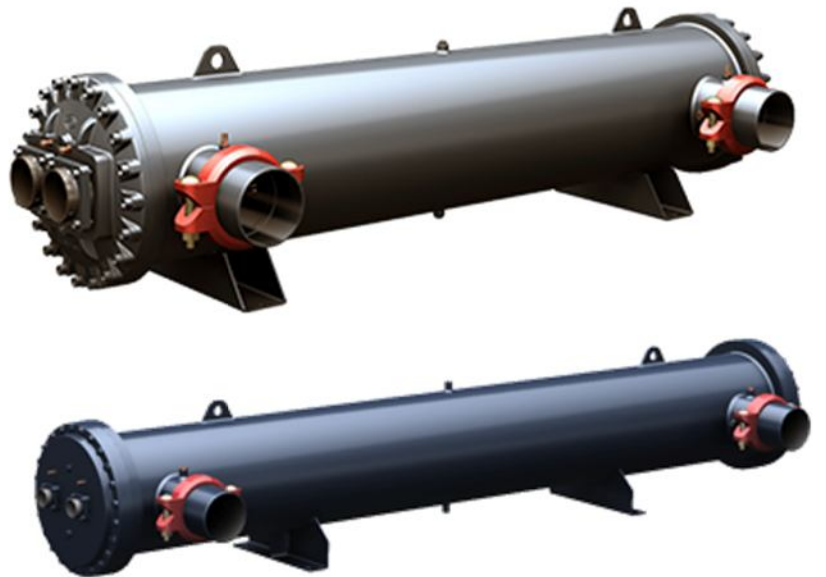

STANDARD SPECIFICATIONS

CONDENSERS COIL

The condenser coils are built up microchannel technology. Integral NOCOLOK brazing low contact resistance improve the heat transfer performance perfectly. AL-AL structure without electric potential difference makes high corrosion resistance. The advantages of microchannel condensers over finned-tube coil are:

- Smaller diameter, more tube holes and larger internal surface intensify unit capacity as per volume.
- Small cross sectional area makes low air flow resistance, small eddy area and low noise.
- Parallel arrangement of flat tubes enlarge refrigerant circulation area.
- Adjusting the position and quantity of baffles to adapt to refrigerant phase transition and optimize heat transfer and pressure drop.
- The structure effectively breaks air thermal boundary layer, reducing heat exchanging resistance.
- Waving path makes the contacts longer to intensify heat exchanging.

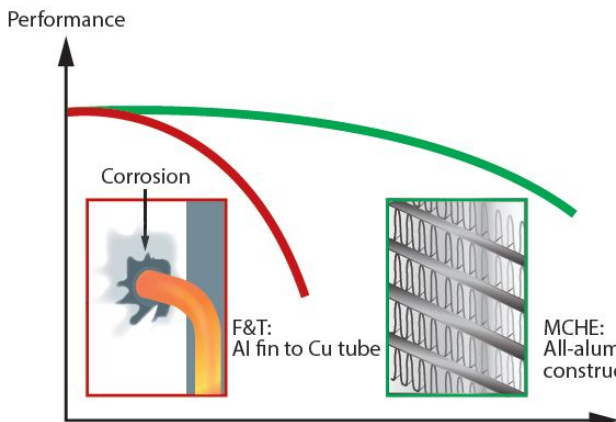
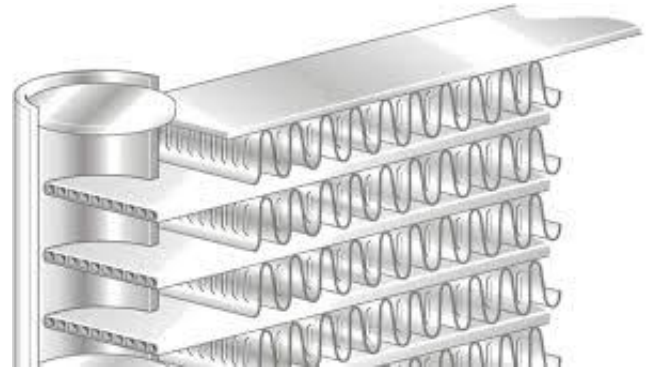
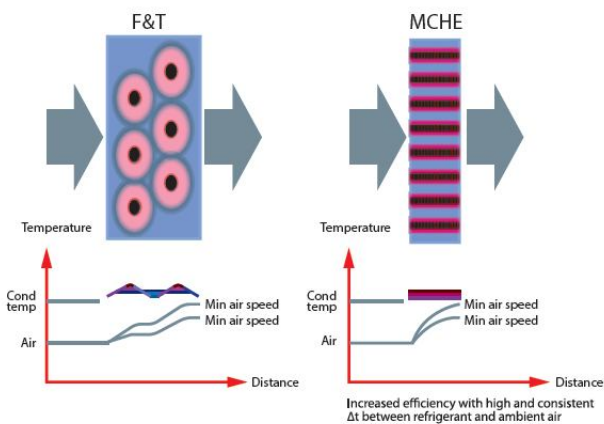

F&T
dust removal difficult - heat transfer loss
high risk of damage during cleaning

MCHE
dust removal easy
immediate performance recovery

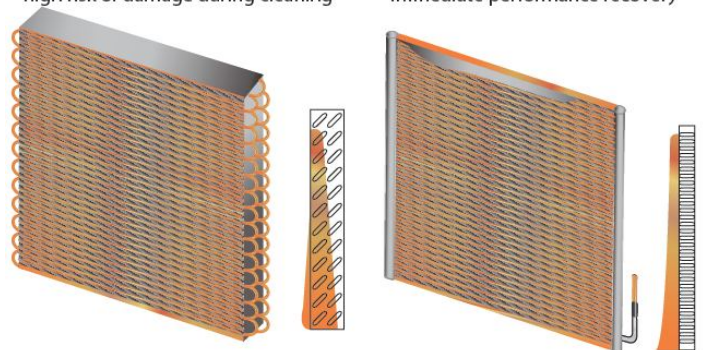

STANDARD SPECIFICATIONS

CONDENSER FAN

Direct drive vertical discharge condenser fans are dynamically balanced. Totally enclosed air over motors completely seal the motor windings to prevent exposure to ambient conditions. Three-phase condenser fan motors with permanently lubricated ball bearings and internal thermal overload protection are provided. Improved acoustic performance due to an optimized blade-design external rotor motors comply with protection class IP54. The winding insulation corresponds to insulation class F. Through the use of deep groove ball bearings, closed on both sides, with specially paired grease lubricant, maintenance-free and low-noise operation is guaranteed.



CONTROL PANEL

Chillers are equipped with a latest version of controller designed to ensure energy saving and unit efficiency. Available functions :

- Monitoring operating parameters including water inlet and outlet temperature, suction and discharge temperature, suction and discharge pressure
- Protecting the system from frosting water
- Stepped or stepless Capacity control
- Controlling Fan start/stop with pressure
- Adjusting Fan speed through controlling inverter (as per request)
- Connection to building Management System (BMS) via MODBUS protocol
- keeping all the faults in the alarm history
- Compressors hour equalization

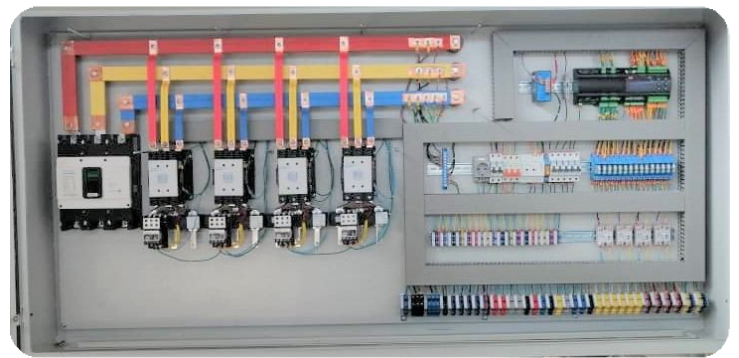

STANDARD SPECIFICATIONS

REFRIGERATION PIPE LINE

- INDEPENDENT REFRIGERATION CIRCUIT PER COMPRESSOR
- ELECTRONIC EXPANSION VALVE: Used to regulate the refrigerant flow to the evaporator and maintain a constant superheat and provide capacity required.
- LIQUID LINE REPLACEABLE CORE TYPE FILTER DRIER: Refrigerant circuits are kept free of harmful moisture, sludge, acids and oil contaminating particles by the filter drier.



- LIQUID LINE MOISTURE INDICATOR SIGHT GLASS: Installed in the liquid line. An easy-to-read color indicator shows moisture contents and provides a mean for checking the system refrigerant charge.
- LIQUID, DISCHARGE AND SUCTION LINES SHUT OFF VALVE
- DISCHARGE, SUCTION AND LIQUID LINE PIPES: All pipelines are sized to minimize pressure drop and keep proper velocity ensuring oil return.
- LIQUID INJECTION KIT: For cooling the compressor in high compressor discharge temperature.

STANDARD SPECIFICATIONS

ELECTRICAL PANEL

- COMPRESSOR PART WINDING START
- COMPRESSOR IN-BUILT PROTECTION DEVICE
- STARTER: The starter is operated by the control circuit and provides power to the compressor motors. These devices are rated to handle safely both RLA and LRA of motors.
- CRANKCASE HEATERS: Each compressor has immersion type crankcase heater. The compressor crankcase heater is always on when the compressors are de-energized. This protects the system against refrigerant Migration, oil dilution and potential compressor failure.
- HIGH PRESSURE SWITCH: This switch provides an additional safety protection in case of excessive discharge pressure.
- LOW PRESSURE SWITCH: This switch provides an additional safety protection in case of very low suction pressure to avoid water freezing.
- UNIT ON-OFF SWITCH: On Off Switch is provided for manually switching the unit control circuit.
- INDICATOR LIGHTS: LED lights indicates power ON to the units, MENU adjustment and FAULT indications due to trip on safety devices.
- UNDER VOLTAGE AND PHASE PROTECTION: This feature protects the chiller against low incoming voltage as well as single phasing , phase reversal and phase imbalance by de-energizing the control circuit.
- FAN MOTOR CIRCUIT BREAKER: For each pair of condenser fan motor.
- COMPRESSOR CIRCUIT BREAKERS: Protects compressor against overload and short circuit. When tripped, the breaker opens the power supply to the compressor and control circuit through auxiliary contacts. These circuit breakers are provided with thermal adjustable switch for precise overload setting.
- EXTERNAL OVERLOAD RELAY FOR EACH COMPRESSOR
- CONTROL FUSED FOR SHORT CIRCUIT PROTECTION

OPTIONAL FEATURES



- **WATER FLOW SWITCH:** Paddle type field adjustable flow switch for water cooler circuits, Interlock into safety circuits so that the unit will remain off unit water flow is determine.
- **UNIT MOUNTING SPRING ISOLATORS:** This housed spring assemblies have a neoprene friction pad on the bottom to prevent vibration transmission.
- **COMPRESSOR SILENCER BOX:** reduces the compressor operating noise and keeps the compressor clean.
- **COPPER FINS/TUBES CONDENSER COILS:** For seashore salty corrosive environments.
- **PRE-COATED ALUMINUM FINS CONDENSER COILS (MHG):** For seashore or acid corrosive environments.
- **BUILDING MANAGEMENT SYSTEM (BMS):** MODBUS, BACNET, and CANBUS protocol
- **NON-FUSED MAIN DISCONNECT SWITCHES:** De-energize power supply during servicing/repair works as well as with door interlock.
- **EVAORATOR HEATER TAPE:** Prevent freezing up of water on low ambient.
- **GROUND CURRENT PROTECTION:** Additional protection for compressor in the case of abnormal current leakage.

TECHNICAL DATA

UNIT MODEL (EACH)		45	50	55	60	70	80	90	100	115	130	140	150
COOLING CAPACITY*	RT	44.6	51.4	58.0	65.1	78.0	88.9	88.9	101.4	116.3	130.9	156.6	156.6
	kW	156.1	179.9	203.0	228.0	273.0	311.0	311.0	355.0	407.0	458.0	548.0	548.0
POWER INPUT (kW)		50.8	61.9	65.5	76.7	88.4	101.5	101.5	123.7	131.1	153.4	177.3	177.3
TOTAL EER (W/W)		2.8	2.7	2.8	2.7	2.8	2.8	2.8	2.6	2.8	2.7	2.8	2.8
COMPRESSOR		Semi Hermetic Compact Screw											
QUANTITY (No.)		1						2					
OIL GRADE		BSE170 Or Equivalent											
OIL CHARGE PER COMPRESSOR (Liter)		8.5	14	14	14	14	8.5	8.5	14	14	14	14	14
CAPACITY CONTROL (%) (STEPPED)		100-25											
CONDENSER TYPE		MICRO CHANNEL											
CONDENSER QTY (No.)		6	6	8	8	10	12	12	12	8	8	10	10
TOTAL FACE AREA (m ²)		6	6	8	8	10	12	12	12	16	16	20	20
CONDENSER FAN		Propeller Direct Driven , 800mm dia , 920 rpm											
FAN QTY (No.)		3	3	4	4	5	6	6	6	8	8	10	10
AIR FLOW RATE (m ³ /h)		67500	67500	90000	90000	112500	135000	135000	135000	180000	180000	225000	225000
MOTOR POWER FAN (kW)		5.7	5.7	7.6	7.6	9.5	11.4	11.4	11.4	15.2	15.2	19	19
EVAPORATOR		Direct Expansion Shell & Tube											
EVAPORATOR QTY (No.)		1											
WATER FLOW RATE (m ³ /h)		24.3	28.0	31.6	35.5	42.5	48.4	48.4	55.3	63.4	71.3	85.3	85.3
WATER VOLUME PER COOLER (Liter)		34.7	98.5	98.5	98.5	98.5	93	93	85.9	139.8	130.8	121	121
WATER CONNECTION SIZE (IN /OUT) DIAMETER (mm)		76	125	125	125	125	125	125	125	150	150	150	150
EXPANSION VALVE		Electronic											
POWER REQUIREMENT		400V/3PH/50Hz											
ECONOMIZER EXPANSION DEVICE		Thermostatic											
ECONOMIZER		Braze Plate Heat Exchanger											
ECONOMIZER LOAD (kW)		16.2	24.1	21.5	22.0	29.5	33.7	33.7	48.3	43.1	43.7	59.1	59.1
REFRIGERATION CIRCUITS (No.)		1						2					
APPROXIMATE WEIGHT (kg)		957	1248	1398	1408	1558	1820	1820	2218	2438	2470	2752	2752
DIMENSION	HEIGHT (m)	2.59	2.59	2.59	2.59	2.59	2.59	2.59	2.59	2.59	2.59	2.59	2.59
	WIDTH (m)	1.27	1.27	1.27	1.27	1.27	1.27	1.27	1.27	2.27	2.27	2.27	2.27
	LENGTH (m)	2.91	2.91	3.88	3.88	4.85	5.82	5.82	5.82	3.88	3.88	4.85	4.85

*Capacity rating are based on Standard ARI-550/590 conditions of: 35 °C (95 °F) ambient/ 7 °C (44.6 °F) Leaving Chilled Water Temperature / 5 °C (9 °F) Inlet-Outlet Water Temperature Difference/ 0.018 m².°C/kW (0.0001 ft². h.°F /Btu) Fouling Factor

TECHNICAL DATA

UNIT MODEL (EACH)		160	170	180	190	200	220	230	240	250	260	270	280
COOLING CAPACITY*	RT	156.6	176.3	176.3	192.0	195.1	216.3	256.9	256.9	256.9	294.9	294.9	294.9
	KW	548.0	617.0	617.0	672.0	683.0	757.0	899.0	899.0	899.0	1032.0	1032.0	1032.0
POWER INPUT (kW)		177.3	198.4	198.4	224.0	215.0	248.0	276.0	276.0	276.0	307.0	307.0	307.0
TOTAL EER (W/W)		2.8	2.8	2.8	2.7	2.8	2.8	2.9	2.9	2.9	3.0	3.0	3.0
COMPRESSOR		Semi Hermetic Compact Screw											
QUANTITY (No.)		2											
OIL GRADE		BSE170 Or Equivalent											
OIL CHARGE PER COMPRESSOR (Liter)		14	14	14	21	21	21	18	18	18	18	18	18
CAPACITY CONTROL (%) (STEPPED)		100-25											
CONDENSER TYPE		MICRO CHANNEL											
CONDENSER QTY (No.)		10	12	12	12	14	14	18	18	18	20	20	20
TOTAL FACE AREA (m ²)		20	24	24	24	28	28	36	36	36	40	40	40
CONDENSER FAN		Propeller Direct Driven , 800mm dia , 920 rpm											
FAN QTY (No.)		10	12	12	12	14	14	18	18	18	20	20	20
AIR FLOW RATE (m ³ /h)		225000	270000	270000	270000	315000	315000	405000	405000	405000	450000	450000	450000
MOTOR POWER FAN (kW)		19	22.8	22.8	22.8	26.6	26.6	34.2	34.2	34.2	38	38	38
EVAPORATOR		Direct Expansion Shell & Tube											
EVAPORATOR QTY (No.)		1											
WATER FLOW RATE (m ³ /h)		85.3	96.0	96.0	104.6	106.3	117.8	139.9	139.9	139.9	160.6	160.6	160.6
WATER VOLUME PER COOLER (Liter)		121	227.4	227.4	212.5	212.5	189.7	224.3	224.3	224.3	301.7	301.7	301.7
WATER CONNECTION SIZE (IN/OUT) DIAMETER (mm)		150	200	200	200	200	200	200	200	200	200	200	200
EXPANSION VALVE		Electronic											
POWER REQUIREMENT		400V/3PH/50Hz											
ECONOMIZER EXPANSION DEVICE		Thermostaic											
ECONOMIZER		Braze Plate Heat Exchanger											
ECONOMIZER LOAD (kW)		59.1	52.5	52.5	79.2	73.1	74.4	86.7	86.7	86.7	89.5	89.5	89.5
REFRIGERATION CIRCUITS (No.)		2											
APPROXIMATE WEIGHT (kg)		2752	3209	3209	3837	4091	4137	4705	4705	4705	5126	5126	5126
DIMENSION	HEIGHT (m)	2.59	2.59	2.59	2.59	2.59	2.59	2.59	2.59	2.59	2.59	2.59	2.59
	WIDTH (m)	2.27	2.27	2.27	2.27	2.27	2.27	2.27	2.27	2.27	2.27	2.27	2.27
	LENGTH (m)	4.85	5.82	5.82	5.82	6.79	6.79	8.73	8.73	8.73	9.7	9.7	9.7

*Capacity rating are based on Standard ARI-550/590 conditions of: 35 °C (95 °F) ambient/ 7 °C (44.6 °F) Leaving Chilled Water Temperature / 5 °C (9 °F) Inlet-Outlet Water Temperature Difference/ 0.018 m².°C/kW (0.0001 ft². h.°F /Btu) Fouling Factor

TECHNICAL DATA

UNIT MODEL (EACH)		300	320	330	340	350	360	380	400	420	430	440	450	480	500	510	530
COOLING CAPACITY*	RT	294.9	332.3	332.3	332.3	369.4	369.4	369.4	390.3	432.6	432.6	432.6	432.6	513.7	513.7	513.7	589.7
	kW	1032.0	1163.0	1163.0	1163.0	1293.0	1293.0	1293.0	1366.0	1514.0	1514.0	1514.0	1514.0	1798.0	1798.0	1798.0	2064.0
POWER INPUT (kW)		307.0	348.0	348.0	348.0	397.0	397.0	397.0	430.0	496.0	496.0	496.0	496.0	552.0	552.0	552.0	614.0
TOTAL EER (W/W)		3.0	3.0	3.0	3.0	2.9	2.9	2.9	2.8	2.8	2.8	2.8	2.8	2.9	2.9	2.9	3.0
COMPRESSOR		Semi Hermetic Compact Screw															
QUANTITY (No.)		2								4							
OIL GRADE		BSE170 Or Equivalent															
OIL CHARGE PER COMPRESSOR (Liter)		18	29	29	29	29	29	29	21	21	21	21	21	18	18	18	18
CAPACITY CONTROL (%) (STEPLESS)		100-25															
CONDENSER TYPE		MICRO CHANNEL															
CONDENSER QTY (No.)		20	22	22	22	24	24	24	28	28	28	28	28	36	36	36	40
TOTAL FACE AREA (m ²)		40	44	44	44	48	48	48	56	56	56	56	56	72	72	72	80
CONDENSER FAN		Propeller Direct Driven , 800mm dia , 920 rpm															
FAN QTY (No.)		20	22	22	22	24	24	24	28	28	28	28	28	36	36	36	40
AIR FLOW RATE (m ³ /h)		450000	495000	495000	495000	540000	540000	540000	630000	630000	630000	630000	630000	810000	810000	810000	900000
MOTOR POWER FAN (kW)		38	41.8	41.8	41.8	45.6	45.6	45.6	53.2	53.2	53.2	53.2	53.2	68.4	68.4	68.4	76
EVAPORATOR		Direct Expansion Shell & Tube															
EVAPORATOR QTY (No.)		1								2							
WATER FLOW RATE (m ³ /h)		160.6	181.0	181.0	181.0	201.3	201.3	201.3	212.6	235.7	235.7	235.7	235.7	279.9	279.9	279.9	321.3
WATER VOLUME PER COOLER (Liter)		301.7	293.5	293.5	293.5	369.7	369.7	369.7	212.5	189.7	189.7	189.7	189.7	224.3	224.3	224.3	301.7
WATER CONNECTION SIZE (IN/OUT) DIAMETER (mm)		200	200	200	200	200	200	200	200	200	200	200	200	200	200	200	200
EXPANSION VALVE		Electrical															
POWER REQUIREMENT		400V/3PH/50Hz															
ECONOMIZER EXPANSION DEVICE		Mechanical															
ECONOMIZER		Braze Plate Heat Exchanger															
ECONOMIZER LOAD (kW)		89.5	115.3	115.3	115.3	122.5	122.5	122.5	146.2	148.8	148.8	148.8	148.8	173.4	173.4	173.4	179.0
REFRIGERATION CIRCUITS (No.)		2								4							
APPROXIMATE WEIGHT (kg)		5126	6230	6230	6230	6628	6628	6628	8120	8212	8212	8212	8212	9348	9348	9348	10190
DIMENSION	HEIGHT (m)	2.59	2.59	2.59	2.59	2.59	2.59	2.59	2.59	2.59	2.59	2.59	2.59	2.59	2.59	2.59	2.59
	WIDTH (m)	2.27	2.27	2.27	2.27	2.27	2.27	2.27	2.27	2.27	2.27	2.27	2.27	2.27	2.27	2.27	2.27
	LENGTH (m)	9.7	10.67	10.67	10.67	11.64	11.64	11.64	13.58	13.58	13.58	13.58	13.58	17.46	17.46	17.46	19.4

*Capacity rating are based on Standard ARI-550/590 conditions of: 35 °C (95 °F) ambient / 7 °C (44.6 °F) Leaving Chilled Water Temperature / 5 °C (9 °F) Inlet-Outlet Water Temperature Difference / 0.018 m².°C/kW (0.0001 ft². h.°F /Btu) Fouling Factor

PERFORMANCE DATA TABLES

LEAVING CHILLED WATER TEMP. (LCWT)	UNIT SIZE	30°C (86°F) AMBIENT TEMPERATURE				
		COOLING CAPACITY		COMP. POWER (kW)	Total EER (W/W)	WATER FLOW (m³/h)
		RT	kW			
7°C	EACH-45	47.1	165	45.3	3.2	25.7
	EACH-50	54.5	190.6	55.7	3.1	29.7
	EACH-55	61.7	216	59.3	3.2	33.6
	EACH-60	68.9	241	68.7	3.2	37.5
	EACH-70	82.3	288	79.4	3.2	44.8
	EACH-80	93.7	328	90.5	3.2	51.1
	EACH-90	93.7	328	90.5	3.2	51.1
	EACH-100	107.4	376	111.1	3.1	58.5
	EACH-115	123.4	432	118.6	3.2	67.2
	EACH-130	138.3	484	137.3	3.2	75.3
	EACH-140	165.4	579	159.3	3.2	90.1
	EACH-150	165.4	579	159.3	3.2	90.1
	EACH-160	165.4	579	159.3	3.2	90.1
	EACH-170	185.1	648	177	3.2	100.9
	EACH-180	185.1	648	177	3.2	100.9
	EACH-190	201.4	705	197.9	3.2	109.7
	EACH-200	204.6	716	189.7	3.3	111.5
	EACH-220	226.6	793	220	3.2	123.4
	EACH-230	267.4	936	243	3.4	145.7
	EACH-240	267.4	936	243	3.4	145.7
	EACH-250	267.4	936	243	3.4	145.7
	EACH-260	307.7	1077	272	3.5	167.6
	EACH-270	307.7	1077	272	3.5	167.6
	EACH-280	307.7	1077	272	3.5	167.6
	EACH-300	307.7	1077	272	3.5	167.6
	EACH-320	349.4	1223	310	3.5	190.4
	EACH-330	349.4	1223	310	3.5	190.4
	EACH-340	349.4	1223	310	3.5	190.4
	EACH-350	366	1281	355	3.2	199.4
	EACH-360	366	1281	355	3.2	199.4
	EACH-380	366	1281	355	3.2	199.4
	EACH-400	409.1	1432	379.4	3.3	222.9
	EACH-420	453.1	1586	440	3.2	246.9
EACH-430	453.1	1586	440	3.2	246.9	
EACH-440	453.1	1586	440	3.2	246.9	
EACH-450	453.1	1586	440	3.2	246.9	
EACH-480	534.9	1872	486	3.4	291.4	
EACH-500	534.9	1872	486	3.4	291.4	
EACH-510	534.9	1872	486	3.4	291.4	
EACH-530	615.4	2154	544	3.5	335.3	

1- ECHA Chillers are rated based on Standard ARI-550/590-98 conditions of: 5 °C (9 °F) Inlet/Outlet Water Temperature Difference and 0.018 m².°C/kW (0.0001 ft². h.°F /Btu) Fouling Factor

2- Direct interpolation is permissible. Do not extrapolate.

3- Energy Efficiency Ratio (EER) is for the overall unit, refer to electrical data for fan power input.

PERFORMANCE DATA TABLES

LEAVING CHILLED WATER TEMP. (LCWT)	UNIT SIZE	35°C (95°F) AMBIENT TEMPERATURE				
		COOLING CAPACITY		COMP. POWER (kW)	Total EER (W/W)	WATER FLOW (m ³ /h)
		RT	kW			
7°C	EACH-45	44.6	156.1	50.8	2.8	24.3
	EACH-50	51.4	179.9	61.9	2.7	28
	EACH-55	58	203	65.5	2.8	31.6
	EACH-60	65.1	228	76.7	2.7	35.5
	EACH-70	78	273	88.4	2.8	42.5
	EACH-80	88.9	311	101.5	2.8	48.4
	EACH-90	88.9	311	101.5	2.8	48.4
	EACH-100	101.4	355	123.7	2.6	55.3
	EACH-115	116.3	407	131.1	2.8	63.4
	EACH-130	130.9	458	153.4	2.7	71.3
	EACH-140	156.6	548	177.3	2.8	85.3
	EACH-150	156.6	548	177.3	2.8	85.3
	EACH-160	156.6	548	177.3	2.8	85.3
	EACH-170	176.3	617	198.4	2.8	96
	EACH-180	176.3	617	198.4	2.8	96
	EACH-190	192	672	224	2.7	104.6
	EACH-200	195.1	683	215	2.8	106.3
	EACH-220	216.3	757	248	2.8	117.8
	EACH-230	256.9	899	276	2.9	139.9
	EACH-240	256.9	899	276	2.9	139.9
	EACH-250	256.9	899	276	2.9	139.9
	EACH-260	294.9	1032	307	3	160.6
	EACH-270	294.9	1032	307	3	160.6
	EACH-280	294.9	1032	307	3	160.6
	EACH-300	294.9	1032	307	3	160.6
	EACH-320	332.3	1163	348	3	181
	EACH-330	332.3	1163	348	3	181
	EACH-340	332.3	1163	348	3	181
	EACH-350	369.4	1293	397	2.9	201.3
	EACH-360	369.4	1293	397	2.9	201.3
	EACH-380	369.4	1293	397	2.9	201.3
	EACH-400	390.3	1366	430	2.8	212.6
EACH-420	432.6	1514	496	2.8	235.7	
EACH-430	432.6	1514	496	2.8	235.7	
EACH-440	432.6	1514	496	2.8	235.7	
EACH-450	432.6	1514	496	2.8	235.7	
EACH-480						
EACH-500						
EACH-510						
EACH-530						

1- ECHA Chillers are rated based on Standard ARI-550/590-98 conditions of: 5 °C (9 °F) Inlet/Outlet Water Temperature Difference and 0.018 m².°C/kW (0.0001 ft². h.°F /Btu) Fouling Factor

2- Direct interpolation is permissible. Do not extrapolate.

3- Energy Efficiency Ratio (EER) is for the overall unit, refer to electrical data for fan power input.

PERFORMANCE DATA TABLES

LEAVING CHILLED WATER TEMP. (LCWT)	UNIT SIZE	37°C (98.6°F) AMBIENT TEMPERATURE				
		COOLING CAPACITY		COMP. POWER (kW)	Total EER (W/W)	WATER FLOW (m ³ /h)
		RT	kW			
7°C	EACH-45	43.7	152.8	52.9	2.6	23.8
	EACH-50	50.7	177.3	63.5	2.6	27.6
	EACH-55	55.7	194.9	69.9	2.5	30.3
	EACH-60	63.7	223	79.7	2.6	34.7
	EACH-70	76.3	267	92.1	2.6	41.6
	EACH-80	86.9	304	105.7	2.6	47.3
	EACH-90	86.9	304	105.7	2.6	47.3
	EACH-100	100	350	126.8	2.5	54.5
	EACH-115	113.4	397	136.3	2.6	61.8
	EACH-130	128.3	449	159.1	2.6	69.9
	EACH-140	153.4	537	184.4	2.6	83.6
	EACH-150	153.4	537	184.4	2.6	83.6
	EACH-160	153.4	537	184.4	2.6	83.6
	EACH-170	172.3	603	207	2.6	93.9
	EACH-180	172.3	603	207	2.6	93.9
	EACH-190	188.3	659	234	2.6	102.6
	EACH-200	191.4	670	226	2.7	104.3
	EACH-220	212.6	744	260	2.6	115.8
	EACH-230	0	0	0	0	0
	EACH-240	0	0	0	0	0
	EACH-250	0	0	0	0	0
	EACH-260	0	0	0	0	0
	EACH-270	0	0	0	0	0
	EACH-280	0	0	0	0	0
	EACH-300	0	0	0	0	0
	EACH-320	326	1141	363	2.8	177.6
	EACH-330	326	1141	363	2.8	177.6
	EACH-340	326	1141	363	2.8	177.6
	EACH-350	370	1295	414	2.8	201.6
	EACH-360	370	1295	414	2.8	201.6
EACH-380	370	1295	414	2.8	201.6	
EACH-400	382.9	1340	452	2.7	208.6	
EACH-420	425.1	1488	520	2.6	231.6	
EACH-430	425.1	1488	520	2.6	231.6	
EACH-440	425.1	1488	520	2.6	231.6	
EACH-450	425.1	1488	520	2.6	231.6	

1- ECHA Chillers are rated based on Standard ARI-550/590-98 conditions of: 5 °C (9 °F) Inlet/Outlet Water Temperature Difference and 0.018 m².°C/kW (0.0001 ft². h.°F /Btu) Fouling Factor

2- Direct interpolation is permissible. Do not extrapolate.

3- Energy Efficiency Ratio (EER) is for the overall unit, refer to electrical data for fan power input.





UNIT DIMENSIONS

EACH 45-50-55-60

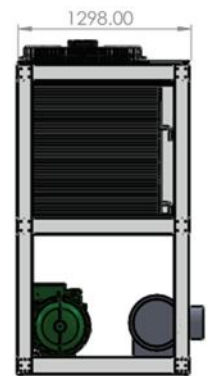
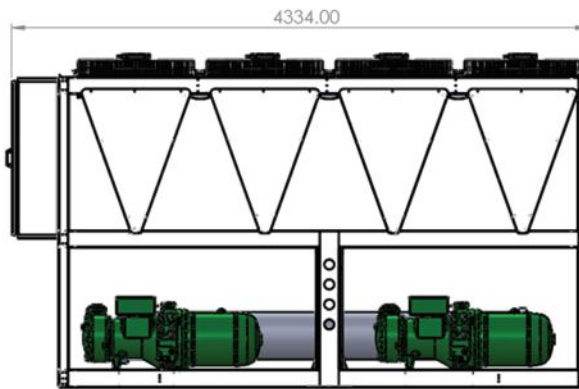
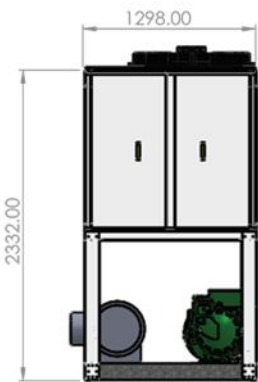
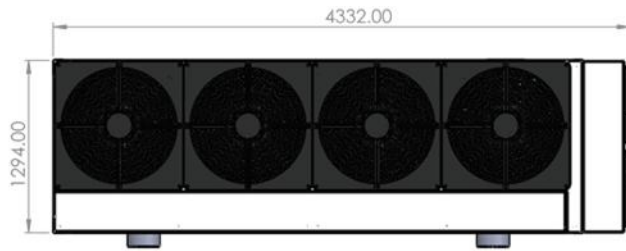
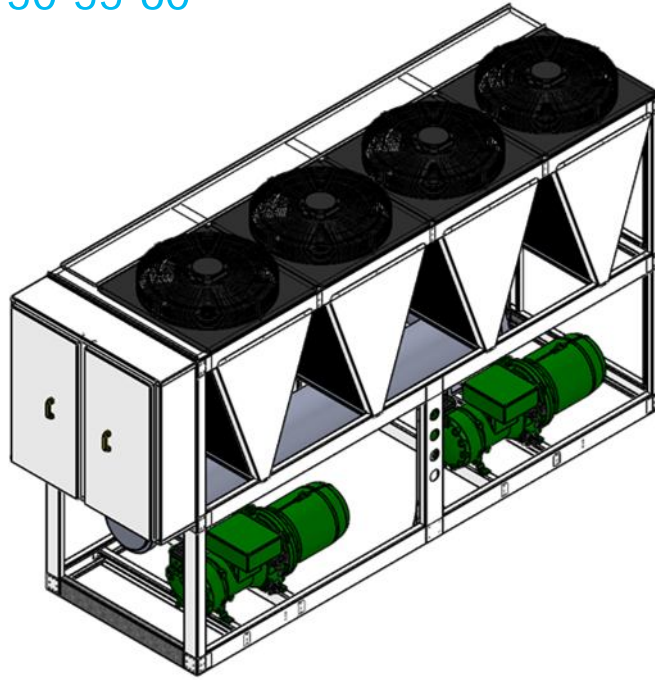

UNIT DIMENSIONS

EACH 70

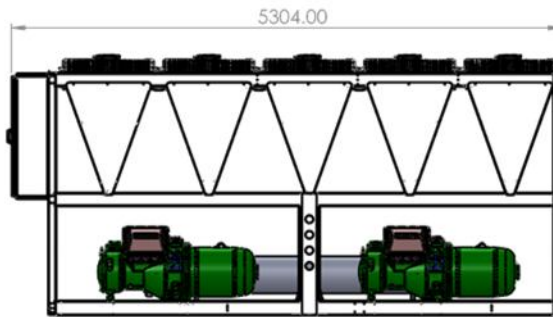
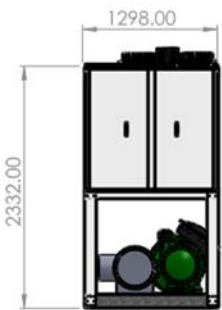
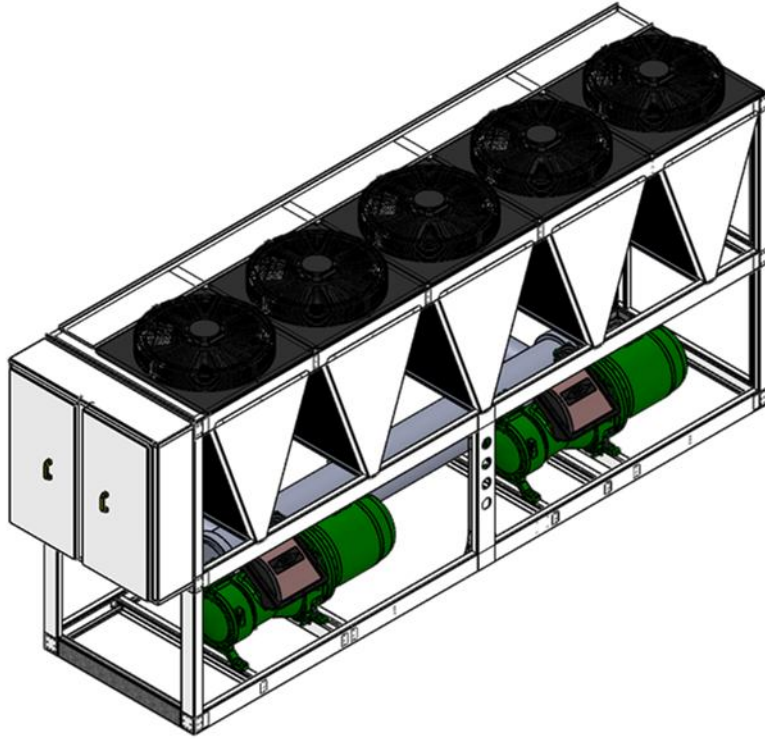

UNIT DIMENSIONS

EACH 80

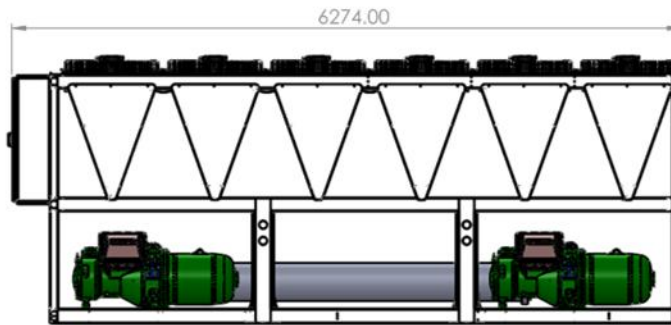
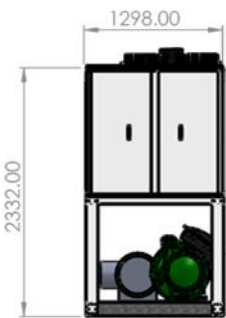
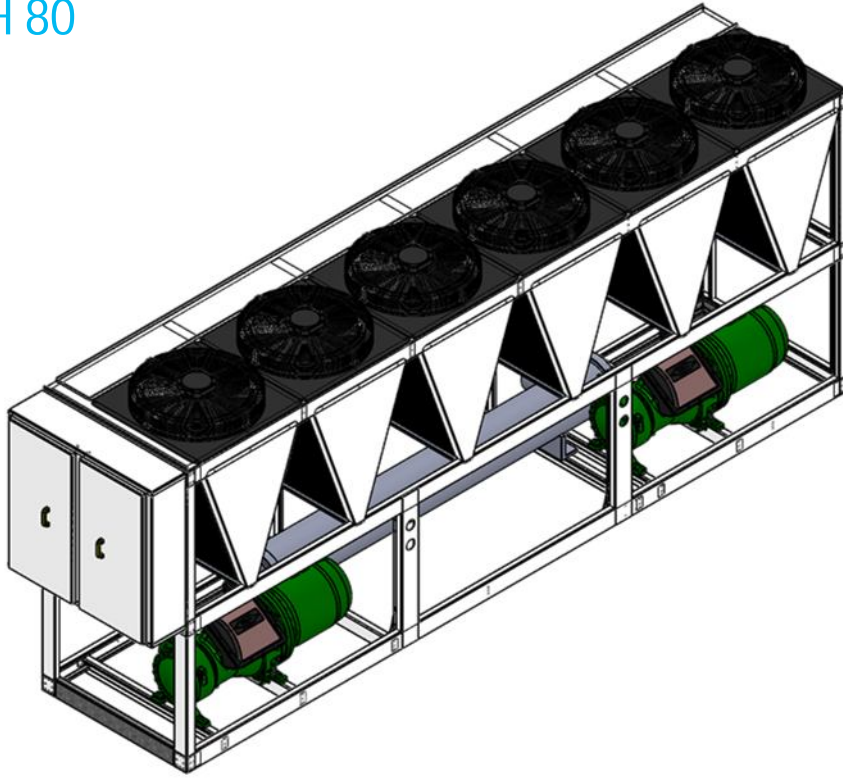

UNIT DIMENSIONS

EACH 90-100-115

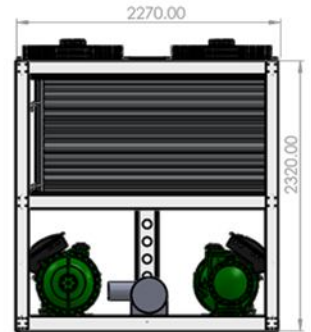
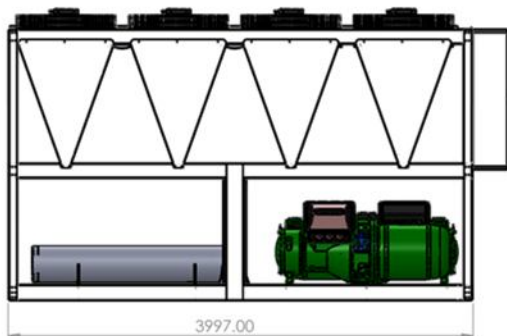
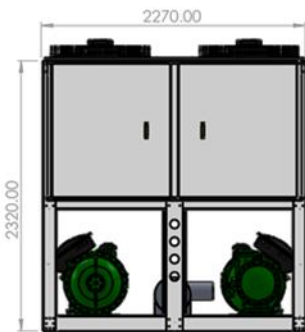
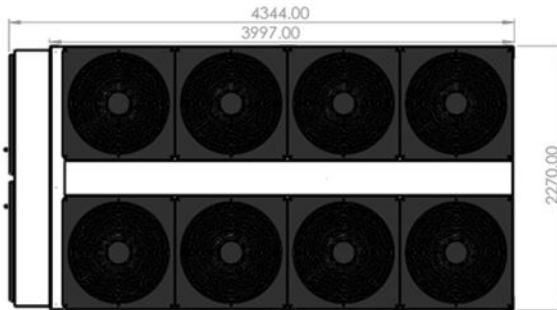
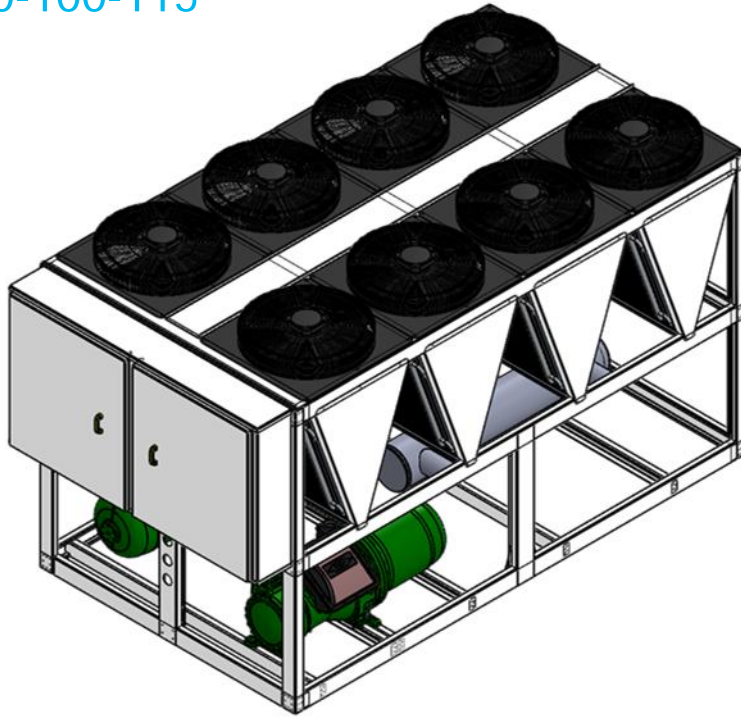

UNIT DIMENSIONS

EACH 130-140-150

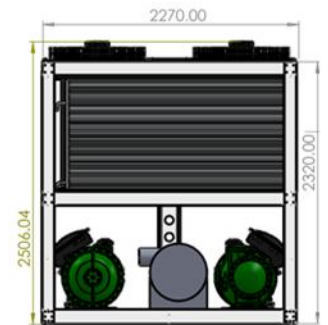
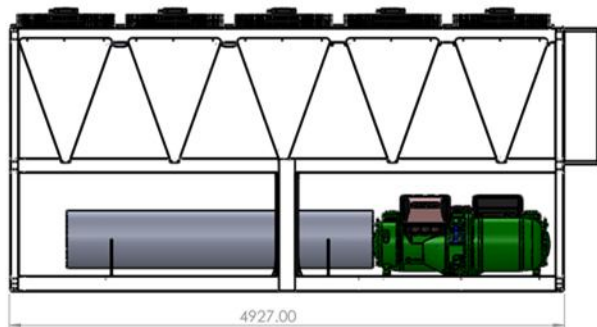
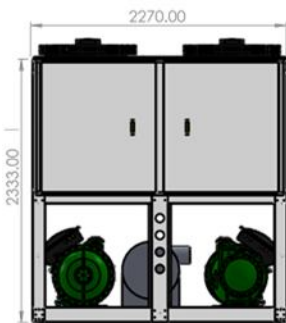
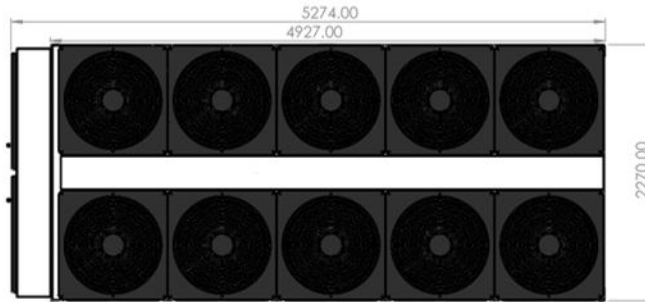
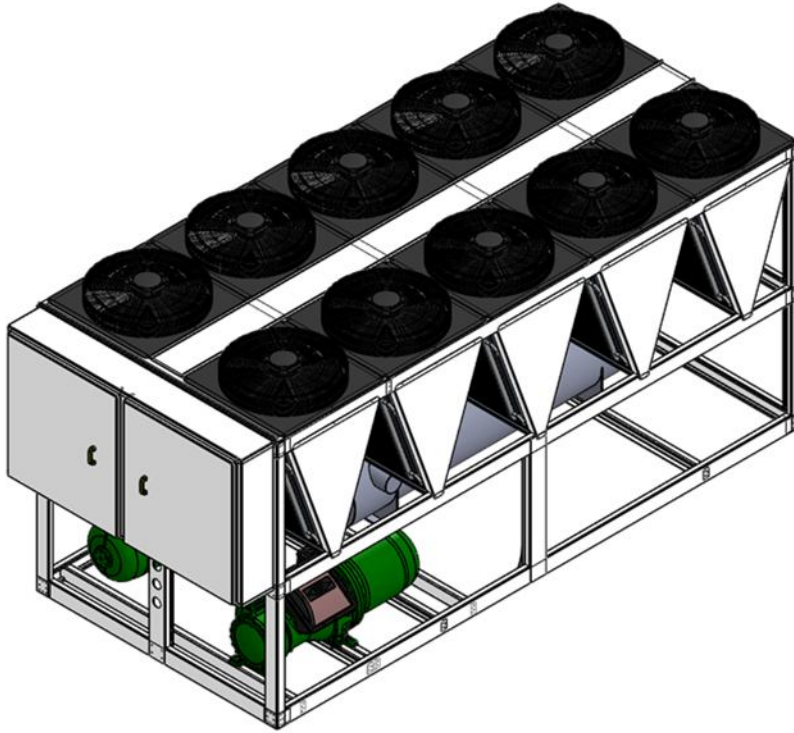

UNIT DIMENSIONS

EACH 160-170

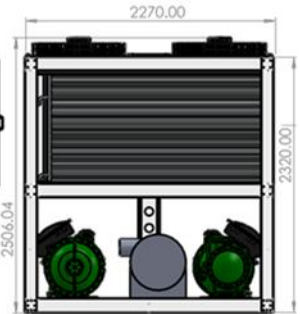
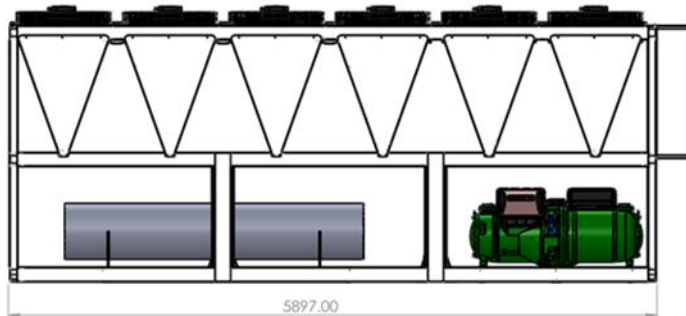
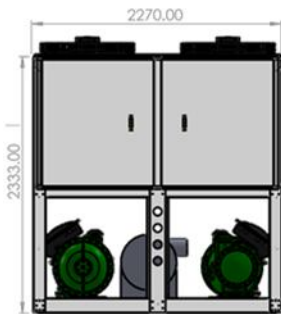
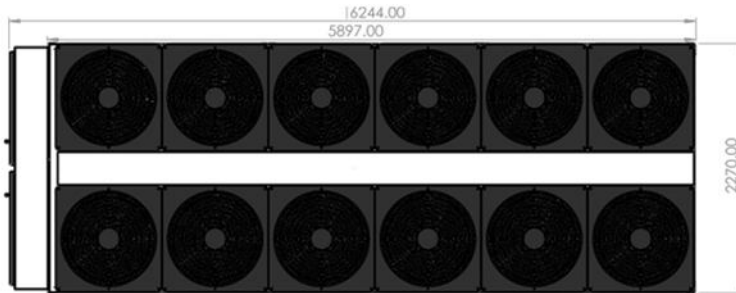
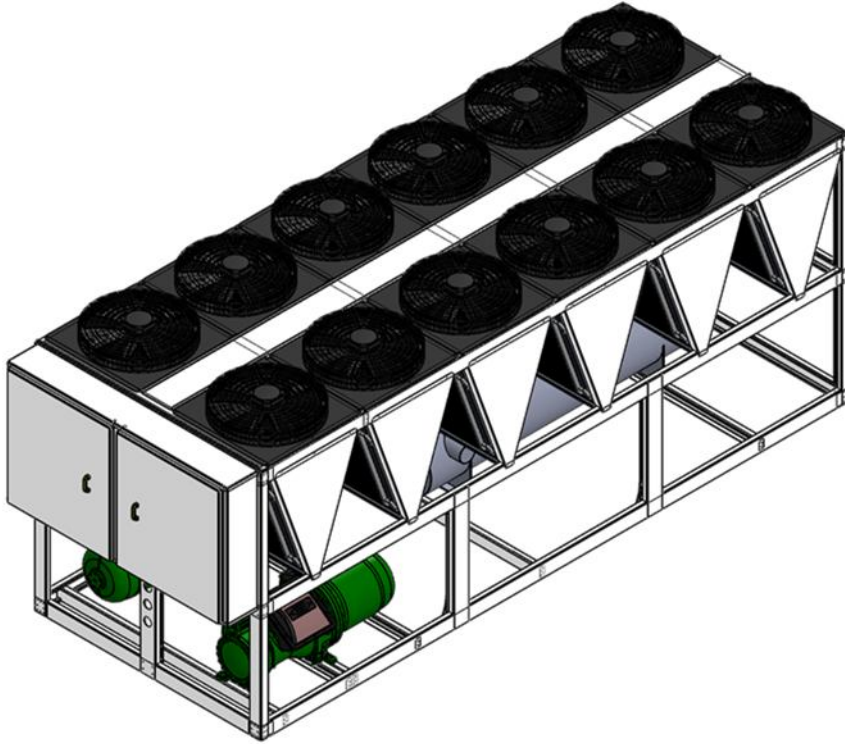

UNIT DIMENSIONS

EACH 180-190-200

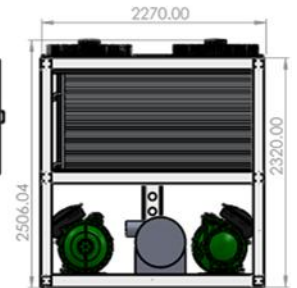
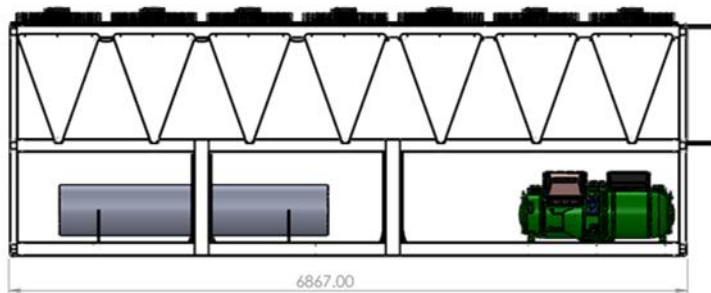
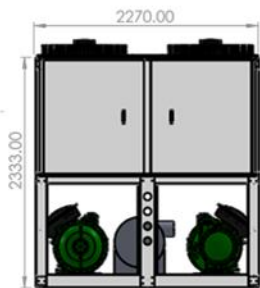
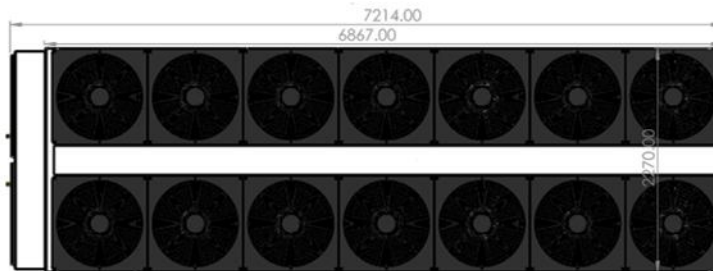
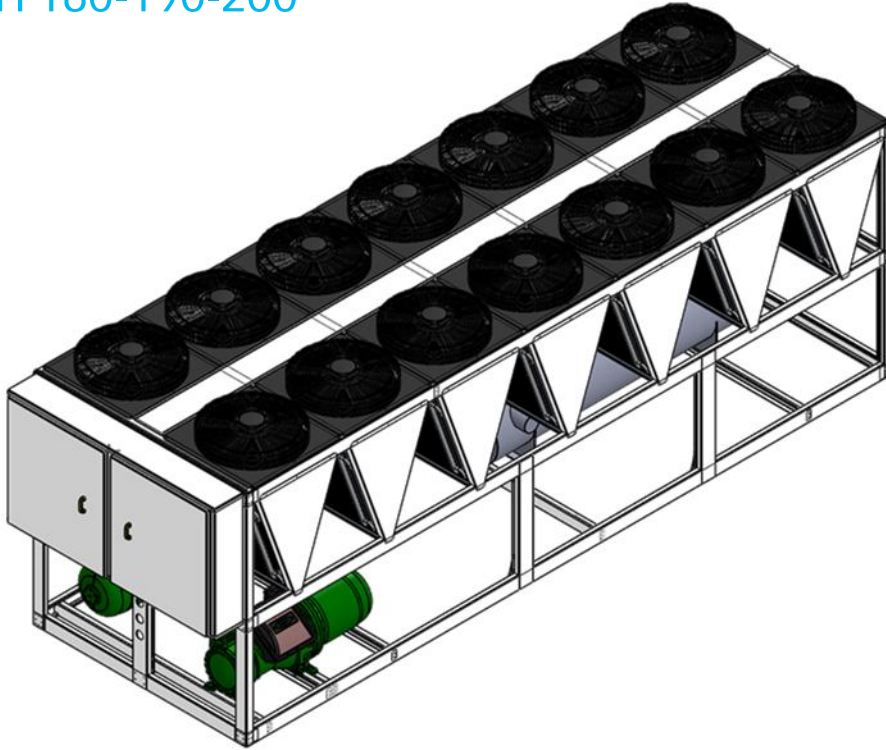

UNIT DIMENSIONS

EACH 220-230-240

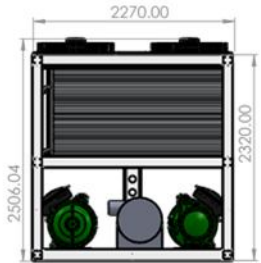
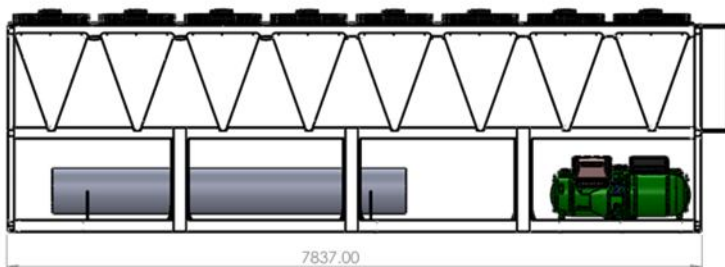
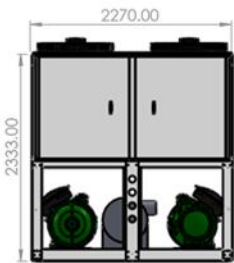
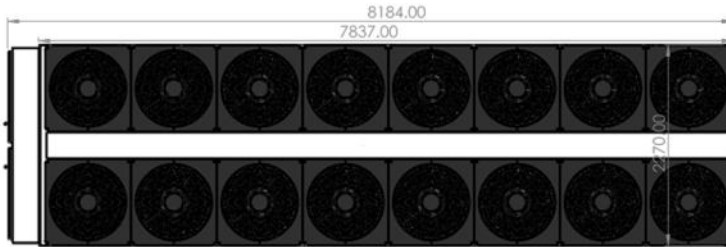
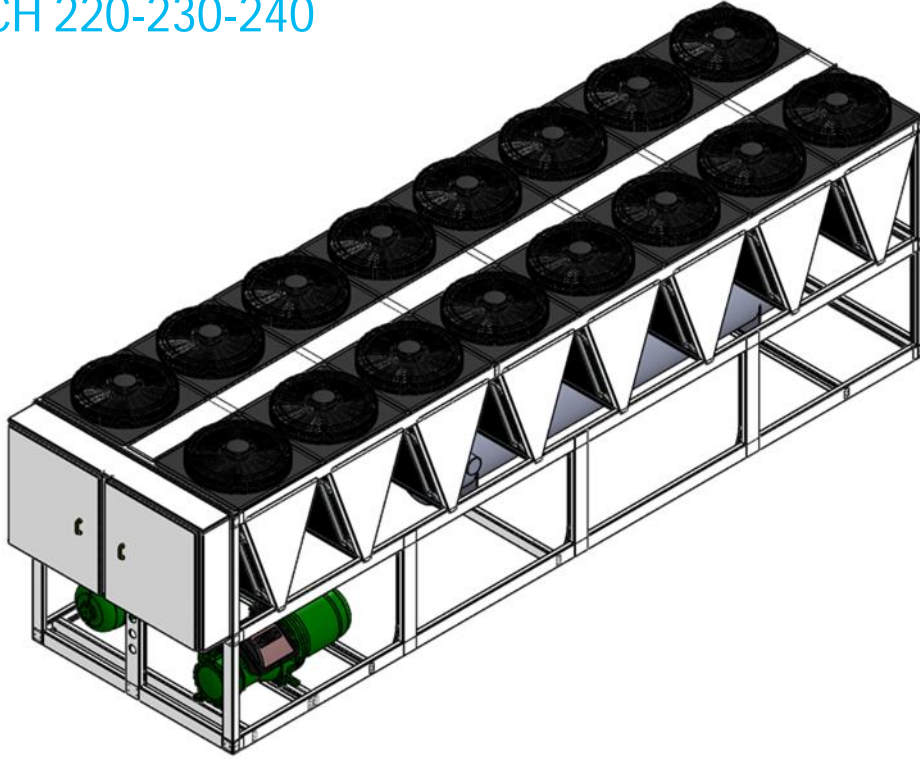

UNIT DIMENSIONS

EACH 250-260-270-280

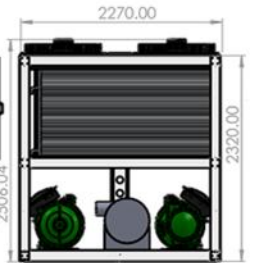
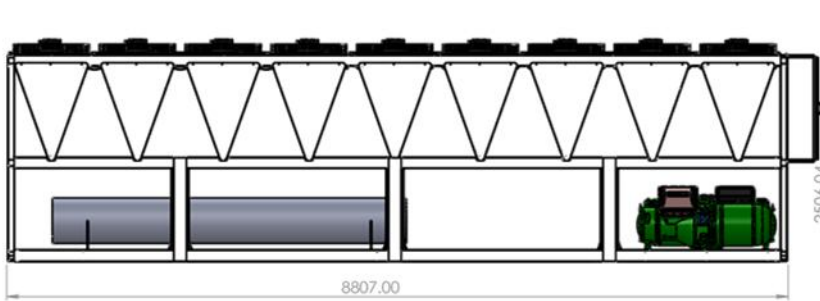
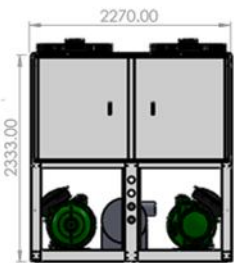
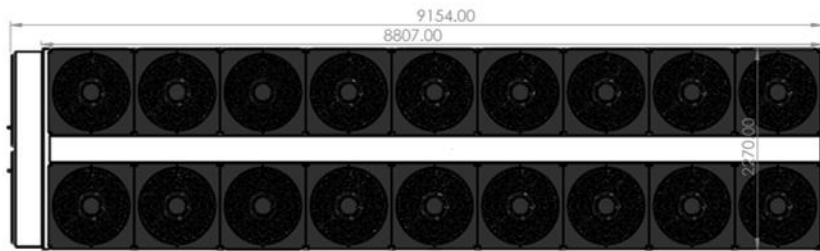
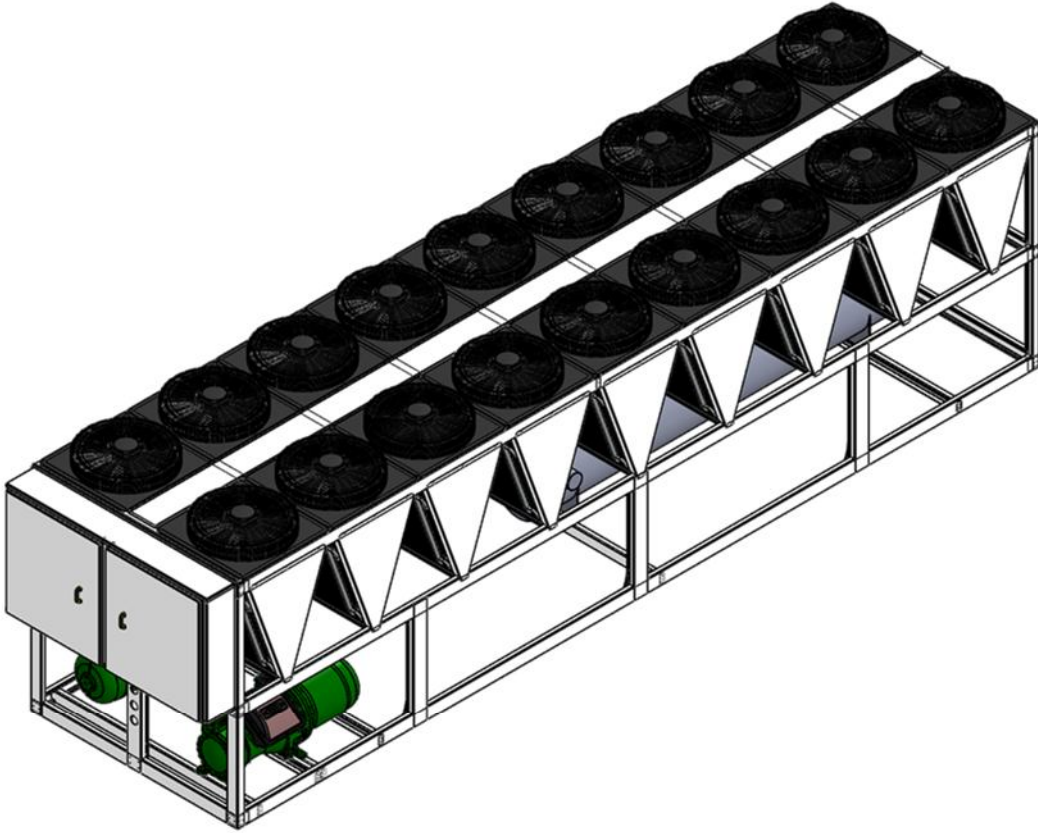

UNIT DIMENSIONS

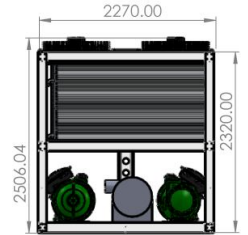
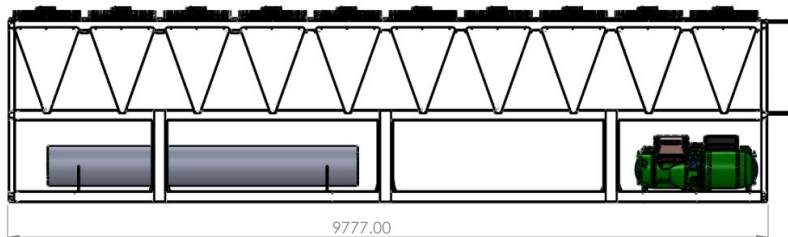
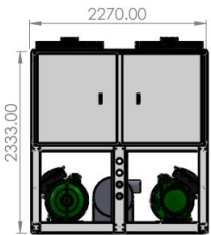
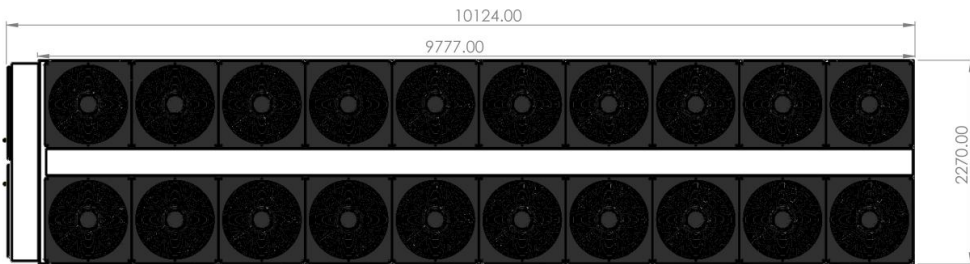
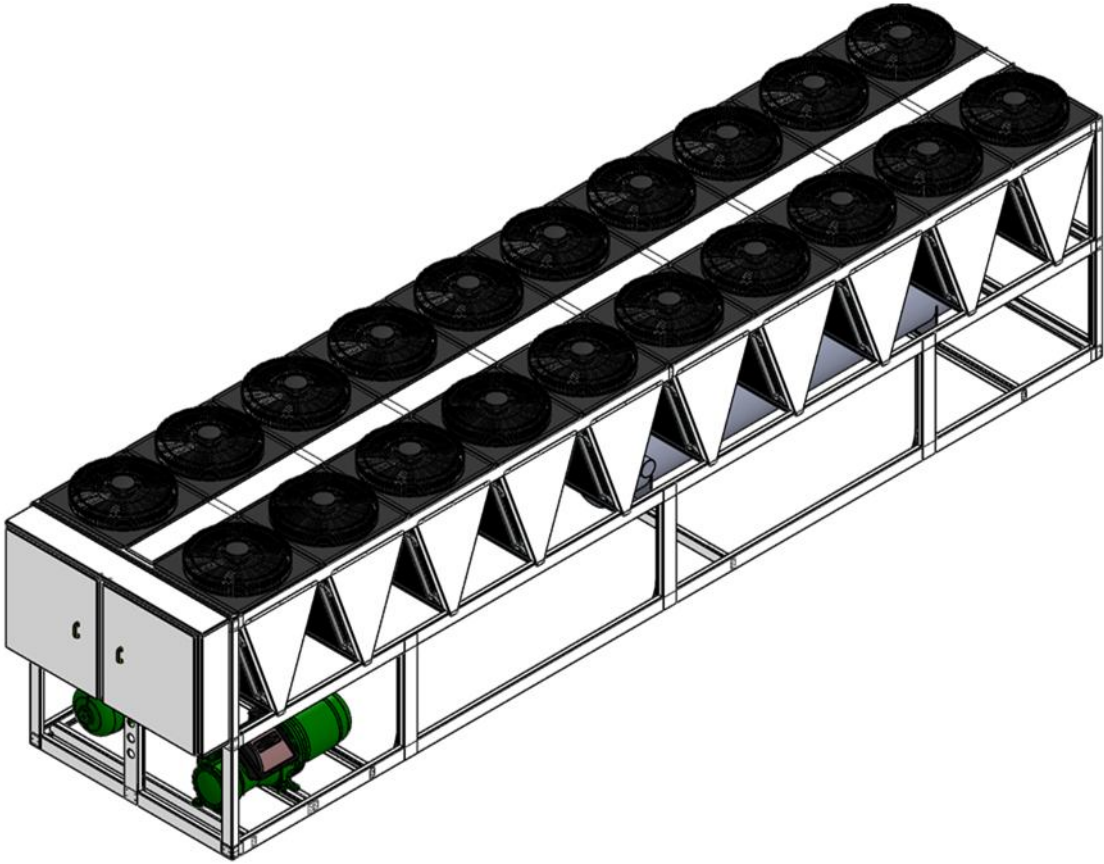

UNIT DIMENSIONS

EACH 300-320

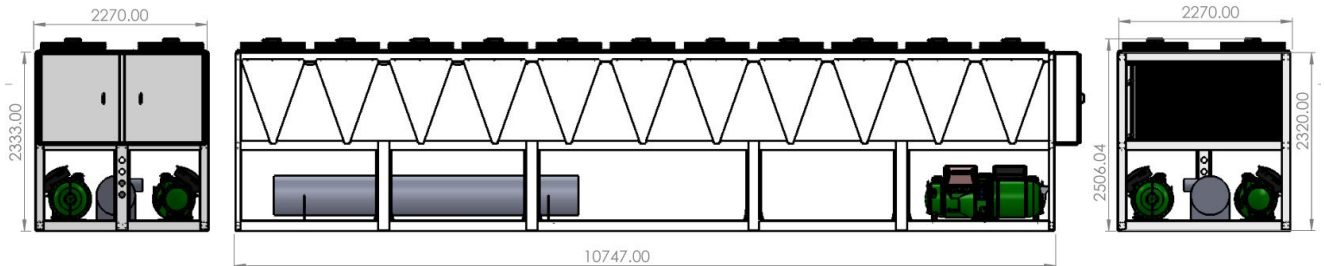
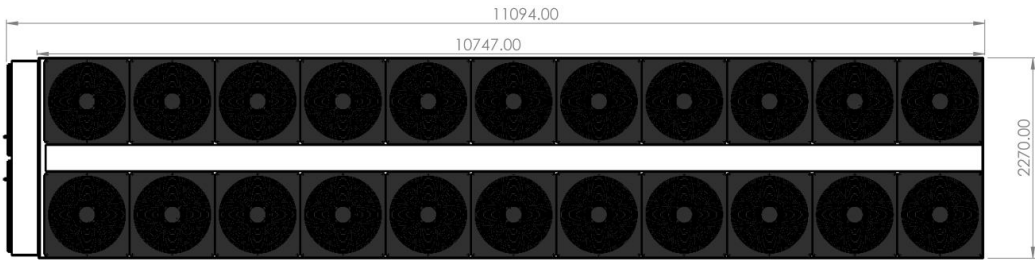
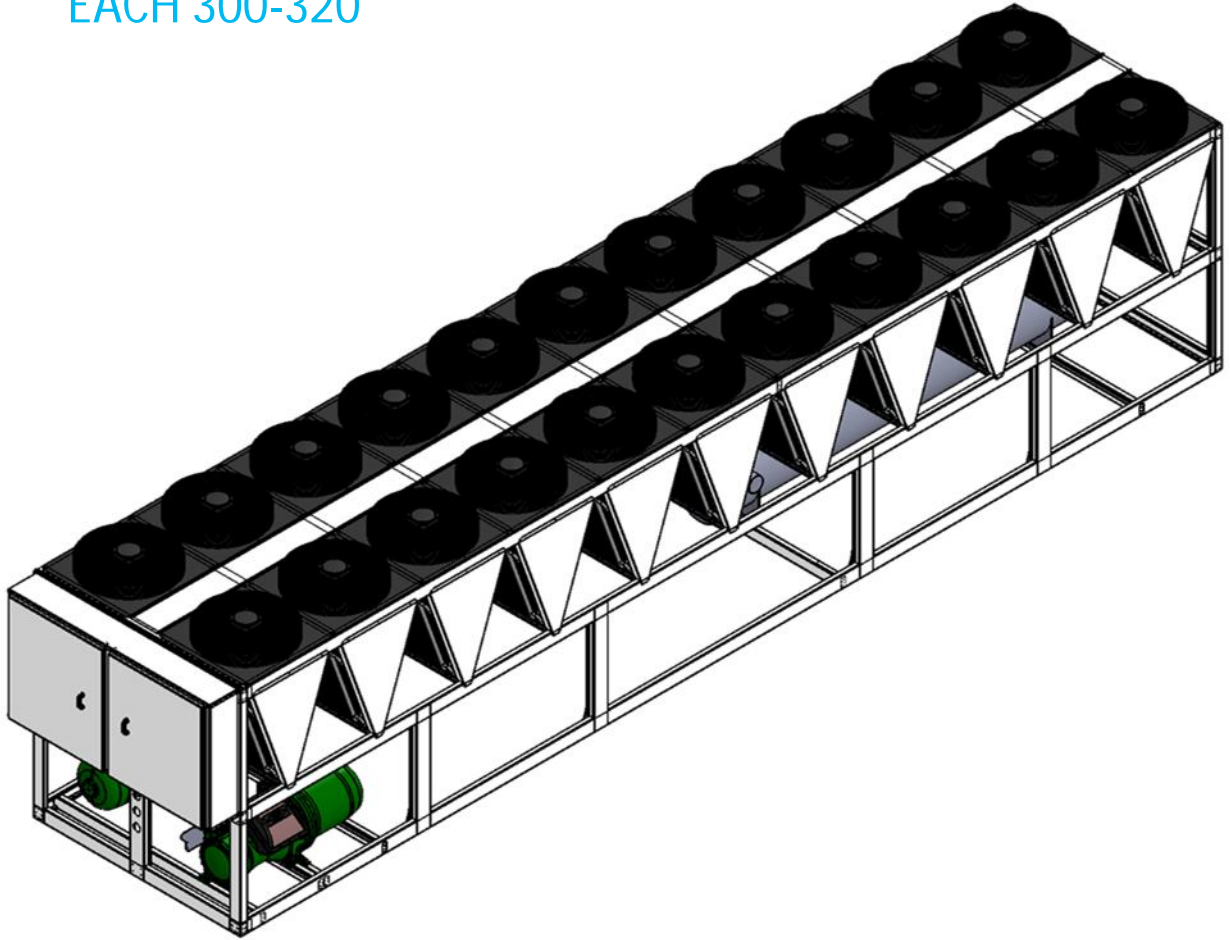

UNIT DIMENSIONS

EACH 330-340-350

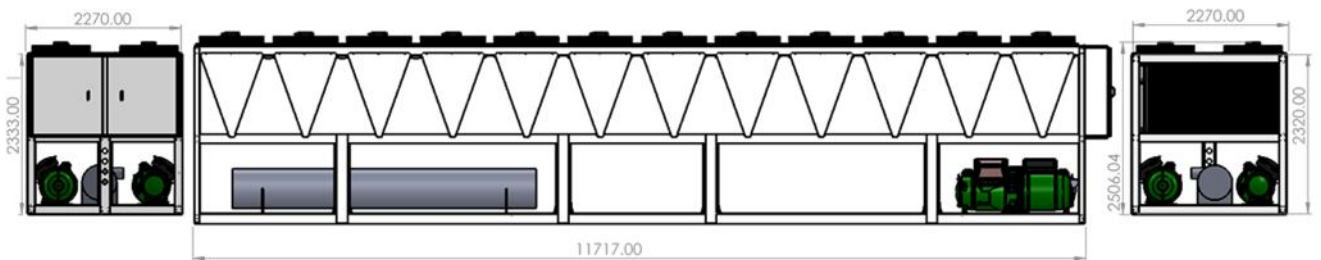
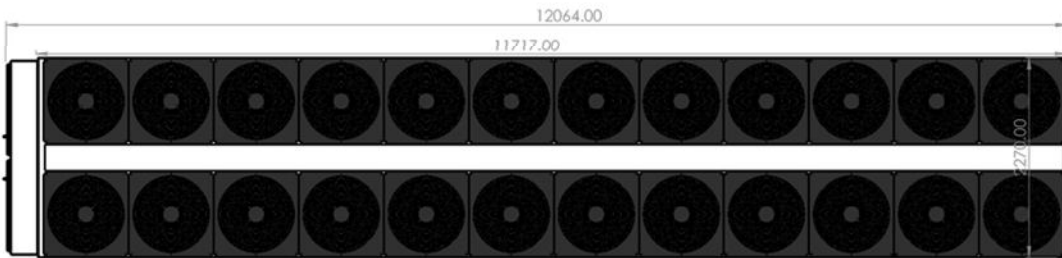
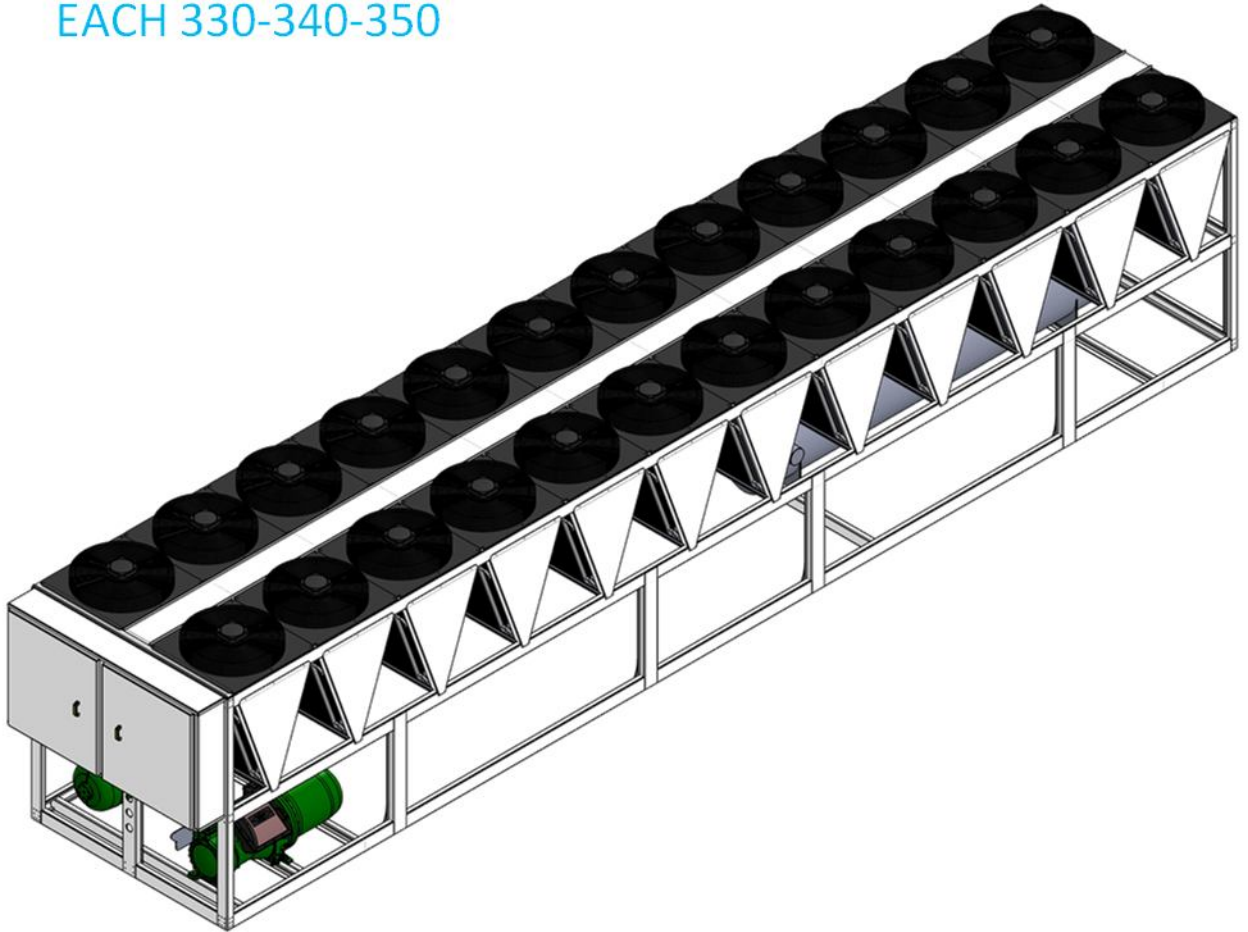

Typical electrical wiring diagram

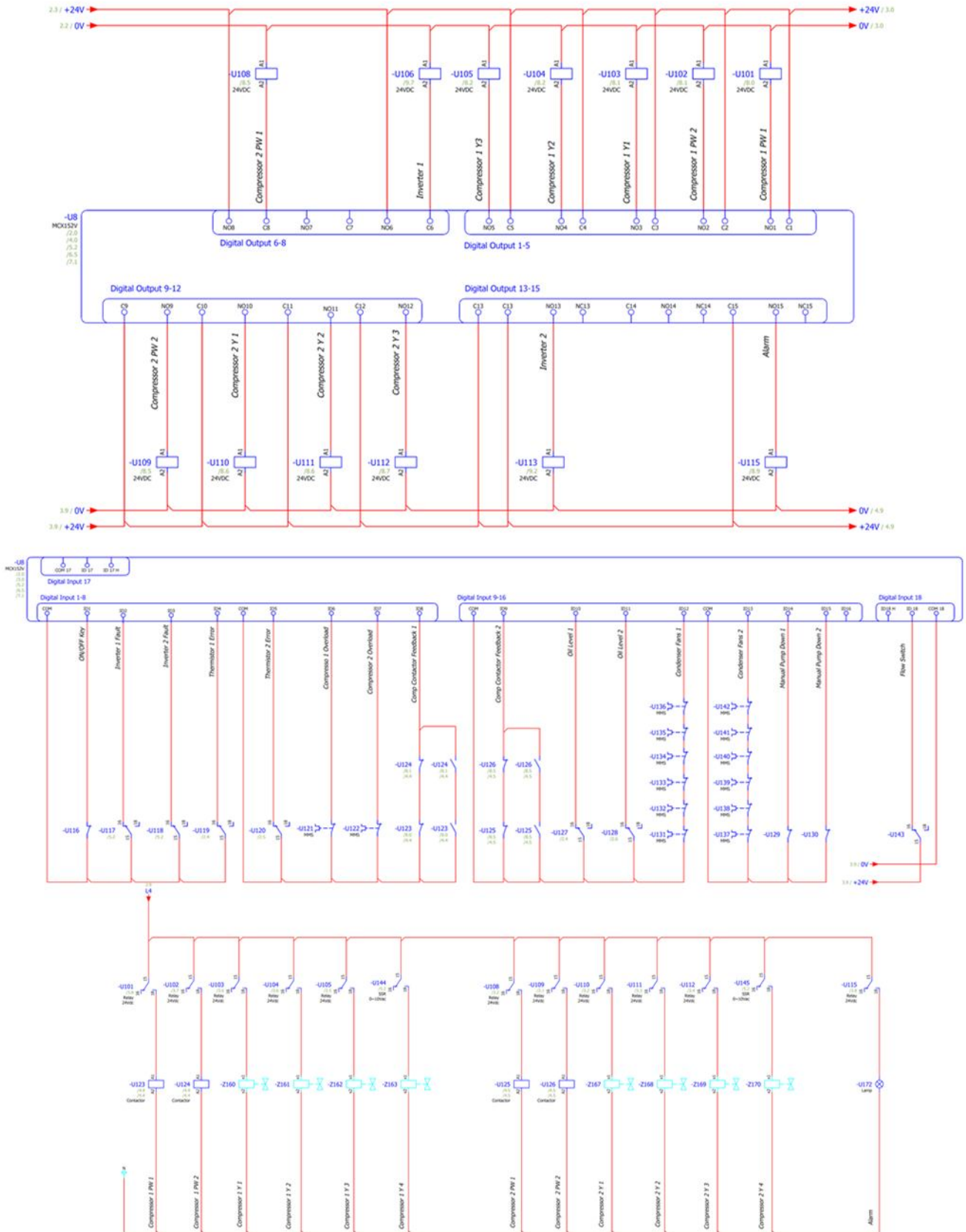

TYPICAL WIRING DIAGRAM

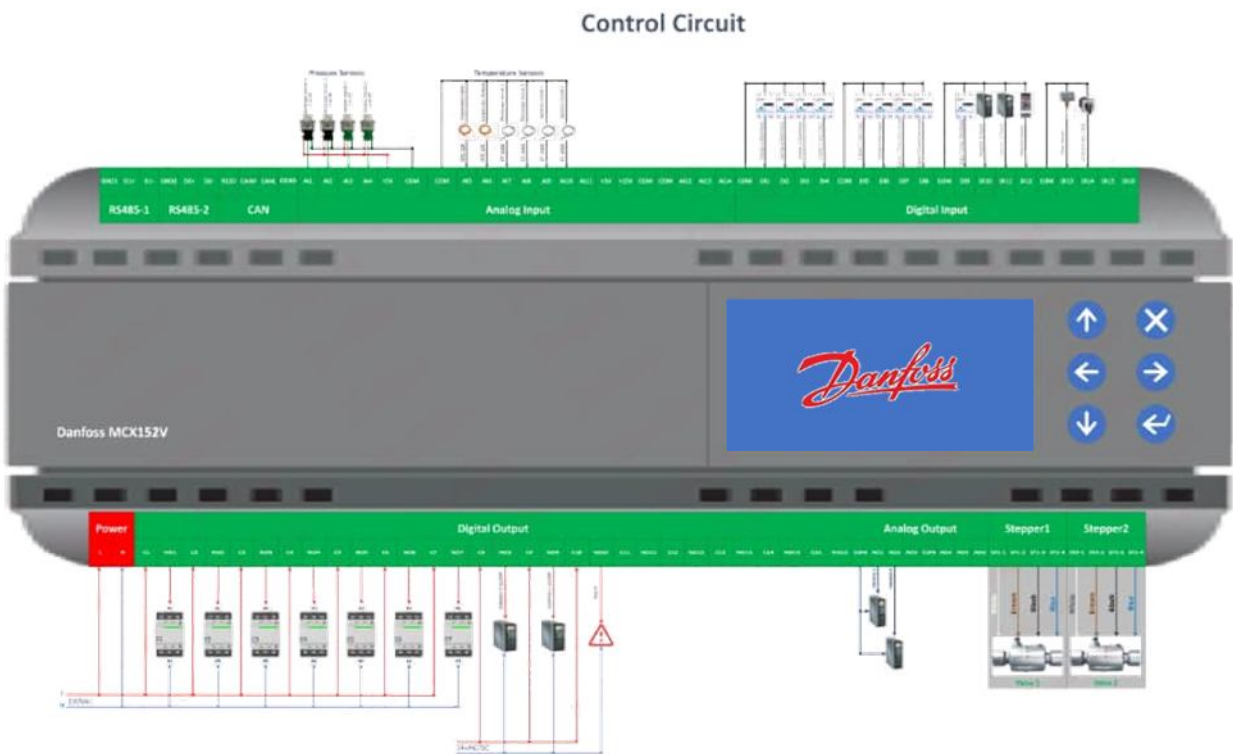

Power Circuit

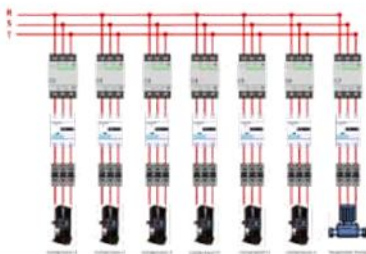



. NOTE .

A large rectangular area with rounded corners, outlined in light blue, containing numerous horizontal light blue lines for writing. The lines are evenly spaced and extend across the width of the page, providing a template for taking notes.

ECO COOLER
AIR CONDITIONER