

ECO COOLER

AIR HANDLING UNIT

Air Flow from 1700 m^3/h to 100000 m^3/h

2022

www.ecocooler.com.tr
info@ecocooler.com.tr

ECO COOLER
AIR CONDITIONER

MULTI STAGE EVAPORATIVE COOLING





Special Public places
Commercial, Office, Hospital, Restaurant,
Coffee shop & Etc .

ECO COOLER

AIR CONDITIONER





Table of Contents

General	8
Introduction	8
Range	8
Flexibility	9
Modular Design	9
Outstanding Features	11
Certificate/quality	13
Customized Solution For Indoor Air Quality	14
Air Handling Unit selection software	15
Range	16
Nomenclature – Standard AHU	16
Standard Selection	17
Airflow rate coverage range of models based on velocity	19
Model Selection Chart	22
Air Handling Unit Details	23
Ultimate casing design and construction	24
• Frame and panel	24
• Access door	28
Mixing Box Section	29
• Mixing box	29
• Damper	29
Filters	30
• Flat Filters	30
• Bag Filters	30
• HEPA Filters	30
• Optional Components	30
Filter standards	32
Fan section	34
• Fans	34
• Motors	34
• Fan & Motor Assembly	34
• Customized Fan Assembly	34
• Fan Mounting in the Different Orientations	34

Table of Contents

Coil Section	37
• Cooling & Heating Coils	37
• Moisture Eliminator	38
• Optional Features of Coil	38
• UV Light	39
• Electric Heater	39
• Heat recovery	39
Control equipment	40
• Variable Frequency Drive	40
• Control valve	41
• Damper actuator	41
• Steam Humidifier	42



GENERAL

Knowledge of our customer's needs as well as the long-term experience of our team has enabled us to develop and launch a new generation of air-handling units. This new generation features not only significantly better parameters but also even greater reliability. New ECO COOLER air-handling units significantly enhance the quality level of RIC air-handling units and set a new, higher standard.

ECO COOLER air handling units allow offering the customer reliable and quality equipment which technical parameters allow to create not only comfortable conditions of a microclimate in various premises, but also to correspond to modern ecological and energy efficient requirements.

INTRODUCTION

Increasing environmental pollution, the quality of air that we breathe is of vital importance. Air handling units are designed for essential features and sensitive installations of high-demanding air conditioning applications like hospitals, shopping mall, oil refineries, industries, electronic facilities, etc. The purpose of this catalogue is to guide the consulting engineers in the preliminary selection of ECO COOLER Air Handling Units. However, if required, our local sales office will assist to provide a computerized selection to confirm or complete your preliminary selection.

RANGE

A wide standard range covers air flow rates from 1700 m³/h up to 100,000 m³/h, with the possibility to choose the most appropriate transverse velocity, depending on the treatment required. In addition, with the same air flow, the flow section (width x height) can be adapted to the dimensional constraints of the installation. All sizes are modularly constructed to facilitate transport and easy assembly on site. With the absence of any welding points the AHU units, on request, can be supplied completely dismantled to allow assembly directly on site.

FLEXIBILITY

ECO COOLER AHUs offer the ultimate in dimensional, material, and component flexibility. ECO COOLER AHUs have the same appeal for both “standard” and “custom” markets. How an air handling unit is designed and built determines how well it performs.

Engineering Flexibility

- Variety of case sizes.
- Material and component flexibility.
- Variable sized inlet and discharge openings.
- stacked and custom configurations.
- Panels are individually removable without affecting structural integrity.

Dimensional Flexibility

We can design our AHUs to fit the application and the space. With up to 34 case sizes and hundreds of cross-sectional possibilities, we can design the best match for your application.

Material Flexibility

A complete line of construction materials are available, including galvanized steel, aluminum, painted steel, stainless steel, and more. ECO COOLER AHUs can handle a multitude of environments, from the most benign to the most corrosive.

MODULAR DESIGN

Based on modularity and a flexible approach, the unique ECO COOLER Air Handling Unit allows you to choose the exact level of functionality required by a specific project. The modules are joined together and with all the functionalities contained in just one unit. Installation and maintenance, therefore, have never been seen so easier.

RELIABLE BRAND



OUTSTANDING FEATURES

Air Handling Unit

- 34 different models of units within a range of airflow rate 1700-100000 m³/h.
- The procedure of design, manufacturing, and providing equipment are in accordance with **VDI 6022**
- The unit casing is made up of panels and frame. Panel construction is a double skin sandwich panel with 50-mm injected polyurethane foam with a density of 40 kg/m³ in accordance with **DIN EN 13053-6.2**. The panel inner skin is made of Stainless steel or galvanized steel sheet coated by polyester electrostatic powder. Panel outer skin is made of galvanized steel sheet coated by PVC. The frame is built by PROLAM aluminum profile. The frame inner side surface is curved and smooth to avoid contamination deposition.
- PROLAM frame classifications in thermal transmittance and thermal bridging is **T1** and **TB1** in accordance with **EN1886**.



OUTSTANDING FEATURES

Air Handling Unit

- The access door is equipped with an adjustable polyamide lock and hinge and sealing gasket suitable for negative and positive pressure conditions.
- Fans used for pressurizing the supply or return/exhaust air in the air handling units may be of many classification groups as per the application or requirement (with forward and backward curved blades, belt-driven or direct-driven (plug, EC etc..)). All of fans are provided by European brands.
- With the fan and motor assembly mounted on a common base with shock absorber and the fan outlet isolated from the casing by a flexible connection and completely separated from moving parts.
- Classes for fan motors is of IE3 for efficiency, IP 55 for insulation, and F for protection. Higher classes can be delivered as option.
- Dampers: made of aluminum airfoil-shaped profile with fibered polypropylene gears, easy installation of the motor.
- Cooling and heating coils: tube material is copper and fin material is copper or aluminum. Fin arrangement is a V-waffled louvered enhanced type. The fin may be coated (epoxy, hydrophilic) or be Blygold to enhance the resistance against corrosion and humid and acidic environments.
- Various filters are available ranging from coarse filters (Panel type, efficiency: G2-G4), fine filters (Bag and compact types, efficiency: M6 – F9) to high efficiency filters (H13-H14-U15). Some special filters such as active carbon filters and UV lamps can also be provided. Filters are tested in accordance with DIN EN 779 and installed in accordance with DIN EN 13053-6.9.2.
- Drain pan: made of painted galvanized steel or stainless-steel sheet. All sections of the unit can be equipped with the drain pan.



Certificates / quality

EC Directives



With the CE mark, the manufacturer declares that, pursuant to EU Regulation 765/2008, the product complies with the applicable requirements laid down in the Community harmonization legislation.

EMC Directive



These products comply with Directive 2004/108/EC Electrical compatibility of electrical and electronic products

TS EN 61000-6-2:2019 IEC 61000-6-2:2016 RLV
 TS EN 61000-6-2:2019 IEC 61000-6-2:2018 RLV

ISO 9001:2015

ISO 10002:2018

ISO 14001:2015

ISO 45001:2018

GMP – ISO 22716



Certification by the International Standardization Organization (ISO) ensures that an organization can consistently deliver a product or service that meets the customer's contractual requirements by following documented processes. The ISO 9001 quality assurance model establishes the requirements for an organization whose business processes range from design and development to production.



CUSTOMIZED SOLUTION FOR INDOOR AIR QUALITY

Customized Applications Include:

- Flexible Cabinet Sizing
- Galvanized, Aluminum or Stainless-Steel Panels with the various thickness such as 0.8, 1.0, 1.2 & 1.6
- Inner Painted Panels.
- Selection of Drain Pan Materials.
- Mixing Boxes / Economizers.
- Multiple Coil Section Depths.
- Integral face and By-Pass Dampers.
- Variety of fans - Belt or Direct Drive, Forward or Backward curved or Airfoil , Plug Fans.
- Motors – Standard and Energy Efficient (IE1-IE2-IE3)
- Humidifier and Dehumidifier sections.
- Filters – panel, Bag , compact, HEPA, carbon active
- Digital Controls
- Optional Accessories – View Port, Hinge Door, Lights, etc.

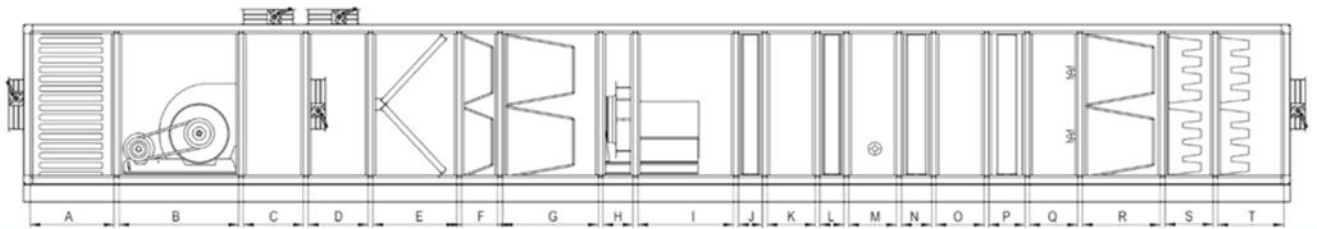

Air Handling Unit																				
Section	A	B	C	D	E	F	G	H	I	J	K	L	M	N	O	P	Q	R	S	T
Dimension (mm)	1000	1000	400	400	700	400	800	300	700	300	500	300	500	400	500	400	500	700	400	700
	Silencer	Return Fan	Plenum Box	Mixing Box	Prefilter	Bag Filter M4/M6	Bag Filter F7/F9	Fan Fixed Door	Supply Fan	Preheater	Coil Service Door	Electrical Coil/ Water Heating Coil	Humidifier	Cooling coil	coil service door	DX coil	UV Lamp	Bag Filter F8/F9	Carbon Active Filter	HEPA / ULPA Filter H11-U15

AIR HANDLING UNIT SELECTION SOFTWARE

For selecting air handling units, we use the multi language selection program. AHU SELECTION is the powerful software package developed to offer a quick and comprehensive service for the customer, in order to make the proper technical choice and economic evaluation of each AHU. It is a complete tool that can configure any type of product and respond exactly to the strictest design needs.

The software is an excellent tool for sales engineers, project designers of air handling unit system. The result is a comprehensive economic offer including all the technical data and drawings, the psychometric diagram with the fans' performance curves. Besides the calculations the program also allows you to create the sketches that can be exported to Auto cad.

All the units are designed and developed with special attention to achieve high efficiency of coils, filters & motors.

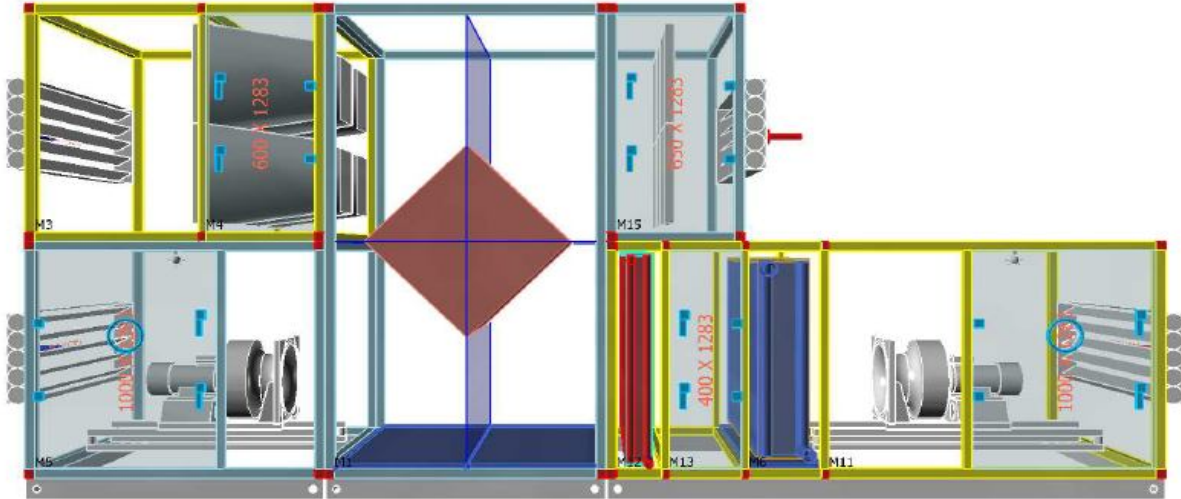
TECHNICAL DATA							
Date	22/05/2021	Rev. Date	06/06/2021				
Project ID	46	Tracking Number	PT-21-140117-FK				
Project Name	AIR HANDLING UNIT - R00						
AHU Name	AHU-01 - (1 QTY)					HVACCALC V. 2.2.3.14 23/05/2021	
AHU Model	EH12008-CHR [1699 PHE CWC HWC]			ECOCOOLER 1/7			
							
hvaccalculator.net							
GENERAL SPECIFICATIONS							
Air Flow	Return Air Flow	Frame	Dimensions (mm)(Size+Pedestal)				
16.990 m³/h	16.990 m³/h	55 Oval Profile	W 1.888 x H 2.915 x L 5.325				
Air Velocity	Return Air Velocity	Insulation Material	Total Weight				
2.07 m/s	2.07 m/s	50 mm Polyurethane	2.251 kg				
Coil Air Velocity	Air Density	Outside Sheet Material	Base Height	Roof (Inside)			
2.26 m/s	1.1943 kg/m³	0.7 mm Painted Galvanize	128 mm	N/A			
Design Outdoor Temp.(W-S)	HRS Capacity (W-S)	Inside Sheet Material	Motor Power				
(-12°C/90%)-(-34°C/36.7%) (KONYA)	103.7 kW - 26.30 kW	0.7 mm Painted Galvanize	11 kW / 11 kW				
Total Heating Capacity	Total Cooling Capacity	Total Sensible Capacity	Total Absorbed Power				
185 kW	140.4 kW	89.08 kW	16.55 kW				
Specific Fan Power(SFP Total)	ErP Code	Real Unit CAL Class -400 Pa	Real Unit CAL Class +400 Pa				
1.513 W/(m³/s)	NRVU - BVU						

RANGE





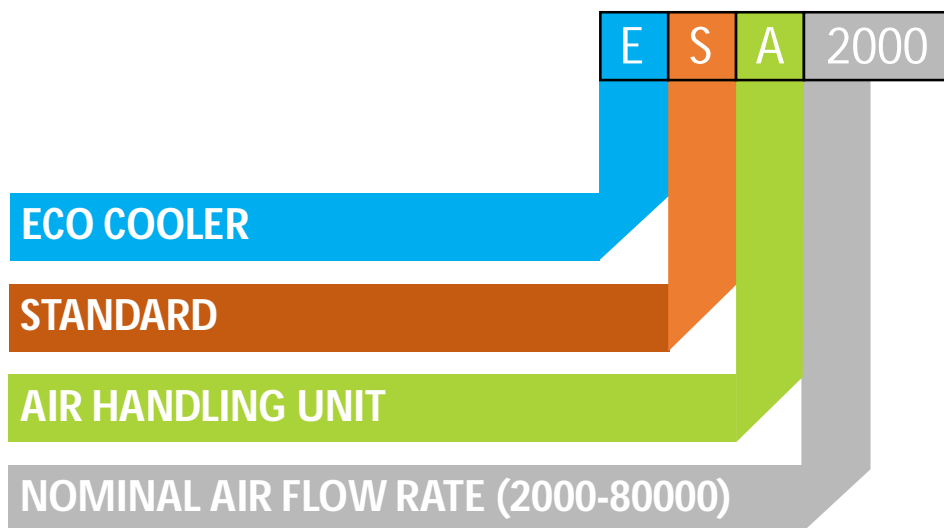





















A wide standard range covers air flow rates from 2 000 cfm up to 80 000 cfm, with the possibility to choose the most appropriate transverse velocity, depending on the treatment required. In addition, with the same air flow, the flow section (width x height) can be adapted to the dimensional constraints of the installation. All sizes are modularly constructed to facilitate transport and easy assembly on site. With the absence of any welding points the AHU units, on request, can be supplied completely dismantled to allow assembly directly on site.

NOMENCLATURE – Standard AHU





























STANDARD SELECTION

AHU series A , B (HOLDER)

Model(ESA)	Nominal air flow rate [m³/h]	Filter arrangement	Internal dimensions (mm)		External dimensions (mm)	
			Width	Height	Width	Height
			ESA 2 000	4 250		616
ESA 3 000	6 375		921	616	1033	728
ESA 4 000	8 500		1226	612	1338	724
ESA 4 500	9 562		921	921	1033	1033
ESA 5 000	10 625		1531	616	1643	728
ESA 6 000	12 750		1226	921	1338	1033
ESA 7 500	15 935		1531	921	1643	1033
ESA 8 000	17 000		1226	1226	1338	1338
ESA 9 000	19 125		1836	921	1948	1033
ESA 10 000	21 250		1531	1226	1643	1338
ESA 12 000	25 500		1836	1226	1948	1338
ESA 12 500	26 562		1531	1592	1643	1704
ESA 14 000	29 750		2141	1226	2253	1338
ESA 15 000	31 875		1836	1592	1948	1704
ESA 16 000	34 000		2446	1226	2558	1338
ESA 17 500	37 185		2141	1592	2253	1704
ESA 18 000	38 250		1836	1897	1948	2009
ESA 20 000	42 500		2446	1592	2558	1704
ESA 21 000	44 625		2141	1897	2253	2009
ESA 24 000	51 000		2446	1897	2558	2009
ESA 25 000	53 125		3056	1592	3168	1704
ESA 28 000	59 500		2446	2233	2558	2345
ESA 30 000	63 750		3056	1897	3168	2009
ESA 32 000	68 000		2446	2538	2558	2650
ESA 40 000	85 000		3056	2538	3168	2650
ESA 48 000	102 000		3666	2538	3778	2650
ESA 56 000	119 000		4276	2538	4388	2650

STANDARD SELECTION

AHU series C , D (SLIDE)

Model	Nominal air flow rate [m³/h]	Filter arrangement	Internal dimensions (mm)		External dimensions (mm)	
			Width	Height	Width	Height
EHA 2 000	4 250		592	660	704	772
EHA 3 000	6 375		880	660	992	772
EHA 4 000	8 500		1185	660	1297	772
EHA 4 500	9 562		880	977	992	1089
EHA 5 000	10 625		1472	660	1584	772
EHA 6 000	12 750		1185	977	1297	1089
EHA 7 500	15 935		1472	977	1584	1089
EHA 8 000	17 000		1185	1282	1297	1394
EHA 9 000	19 125		1777	977	1889	1089
EHA 10 000	21 250		1472	1282	1584	1394
EHA 12 000	25 500		1777	1282	1889	1394
EHA 12 500	26 562		1472	1600	1584	1712
EHA 14 000	29 750		2064	1282	2176	1394
EHA 15 000	31 875		1777	1600	1889	1712
EHA 16 000	34 000		2368	1282	2480	1394
EHA 17 500	37 185		2064	1600	2176	1712
EHA 18 000	38 250		1777	1911	1889	2023
EHA 20 000	42 500		2368	1600	2480	1712
EHA 21 000	44 625		2064	1911	2176	2023
EHA 24 000	51 000		2368	1911	2480	2023
EHA 25 000	53 125		2960	1600	3072	1712
EHA 28 000	59 500		2368	2235	2480	2347
EHA 30 000	63 750		2960	1911	3072	2023
EHA 32 000	68 000		2368	2540	2480	2652
EHA 40 000	85 000		2960	2540	3072	2652
EHA 48 000	102 000		3552	2540	3664	2652
EHA 56 000	119 000		4144	2540	4256	2652

Airflow rate coverage range of models based on velocity

Model	Nominal air flow rate [m³/h]	Velocity*				Internal dimensions		External dimensions	
		m/s				(mm)		(mm)	
		1.5	2	2.5	3	Width	Height	Width	Height
ESA 2000	4 250	2082	2776	3471	4165	616	616	728	728
ESA 3000	6 375	3113	4151	5189	6227	921	616	1033	728
ESA 4000	8 500	4117	5490	6862	8235	1226	612	1338	724
ESA 4500	9 562	4655	6206	7758	9310	921	921	1033	1033
ESA 5000	10 625	5175	6900	8626	10351	1531	616	1643	728
ESA 6000	12 750	6196	8262	10327	12393	1226	921	1338	1033
ESA 7500	15 935	7738	10317	12896	15476	1531	921	1643	1033
ESA 8000	17 000	8248	10998	13747	16497	1226	1226	1338	1338
ESA 9000	19 125	9279	12372	15465	18559	1836	921	1948	1033
ESA 10 000	21 250	10300	13734	17167	20601	1531	1226	1643	1338
ESA 12 000	25 500	12352	16470	20587	24704	1836	1226	1948	1338
ESA 12 500	26 500	13375	17834	22292	26750	1531	1592	1643	1704
ESA 14 000	29 750	14404	19206	24007	28808	2141	1226	2253	1338
ESA 15 000	31 875	16040	21386	26733	32080	1836	1592	1948	1704
ESA 16 000	34 000	16456	21942	27427	32912	2446	1226	2558	1338
ESA 17 500	37 185	18704	24939	31174	37409	2141	1592	2253	1704
ESA 18 000	38 250	19113	25484	31855	38225	1836	1897	1948	2009
ESA 20 000	42 500	21369	28492	35615	42738	2446	1592	2558	1704
ESA 21 000	44 625	22288	29717	37146	44576	2141	1897	2253	2009
ESA 24 000	51 000	25463	33950	42438	50926	2446	1897	2558	2009
ESA 25 000	53 125	26698	35597	44497	53396	3056	1592	3168	1704
ESA 28 000	59 500	29973	39964	49955	59946	2446	2233	2558	2345
ESA 30 000	63 750	31813	42417	53021	63626	3056	1897	3168	2009
ESA 32 000	68 000	34067	45422	56778	68133	2446	2538	2558	2650
ESA 40 000	85 000	42563	56750	70938	85125	3056	2538	3168	2650
ESA 48 000	102 000	51058	68078	85097	102117	3666	2538	3778	2650
ESA 56 000	119 000	59554	79405	99257	119108	4276	2538	4388	2650
ESA 64 000	136 000	68133	90845	113556	136267	4892	2538	5004	2650
ESA 72 000	122 400	76713	102284	127855	153426	5508	2538	5620	2650
ESA 80 000	170 000	85292	113723	142154	170584	6124	2538	6236	2650

* Air velocity is based on internal dimension of models. For coil face velocity, the air flow rate is almost 10% smaller than one presented in the table.

MODEL SELECTION CHART

Model	Nominal air flow rate [CFM]	Velocity* FPM				Internal dimensions (mm)		External dimensions (mm)	
		300	400	500	600	Width	Height	Width	Height
		(CFM)							
2000	2 500	1225	1633	2041	2450	616	616	728	728
3000	3 750	1831	2442	3052	3663	921	616	1033	728
4000	5 000	2422	3229	4037	4844	1226	612	1338	724
4500	5 625	2738	3651	4564	5476	921	921	1033	1033
5000	6 250	3044	4059	5074	6089	1531	616	1643	728
6000	7 500	3645	4860	6075	7290	1226	921	1338	1033
7500	9 250	4552	6069	7586	9103	1531	921	1643	1033
8000	10 000	4852	6469	8087	9704	1226	1226	1338	1338
9000	11 250	5458	7278	9097	10917	1836	921	1948	1033
10 000	12 500	6059	8079	10098	12118	1531	1226	1643	1338
12 000	15 000	7266	9688	12110	14532	1836	1226	1948	1338
12 500	15 500	7868	10490	13113	15736	1531	1592	1643	1704
14 000	17 500	8473	11297	14122	16946	2141	1226	2253	1338
15 000	18 750	9435	12580	15725	18870	1836	1592	1948	1704
16 000	20 000	9680	12907	16134	19360	2446	1226	2558	1338
17 500	21 874	11003	14670	18338	22005	2141	1592	2253	1704
18 000	22 500	11243	14990	18738	22486	1836	1897	1948	2009
20 000	25 000	12570	16760	20950	25140	2446	1592	2558	1704
21 000	26 250	13110	17481	21851	26221	2141	1897	2253	2009
24 000	30 000	14978	19971	24964	29956	2446	1897	2558	2009
25 000	31 250	15705	20940	26175	31409	3056	1592	3168	1704
28 000	35 000	17631	23508	29385	35262	2446	2233	2558	2345
30 000	37 500	18713	24951	31189	37427	3056	1897	3168	2009
32 000	40 000	20039	26719	33399	40079	2446	2538	2558	2650
40 000	50 000	25037	33382	41728	50074	3056	2538	3168	2650
48 000	60 000	30034	40046	50057	60069	3666	2538	3778	2650
56 000	70 000	35032	46709	58386	70064	4276	2538	4388	2650
64 000	80 000	40079	53438	66798	80157	4892	2538	5004	2650
72 000	90 000	45125	60167	75209	90250	5508	2538	5620	2650
80 000	100 000	50172	66896	83620	100344	6124	2538	6236	2650

* Air velocity is based on internal dimension of models. For coil face velocity, the air flow rate is almost 10% smaller than one presented in the table.

PERFORMANCE REPORT FROM SELECTION SOFTWARE

TECHNICAL DATA				ECO COOLER	
Date	21/05/2021	Rev. Date	25/05/2021		
Project ID	50	Tracking Number	PT-21-140118-FK		
Project Name	Packaged heat recovery unit				
AHU Name	Rooftop package - (1 QTY)			AHUSEL V.	2.2.3.14 23/05/2021
AHU Model	EH12008-CHR			ECOCOOLER	1/7

RIGHT VIEW

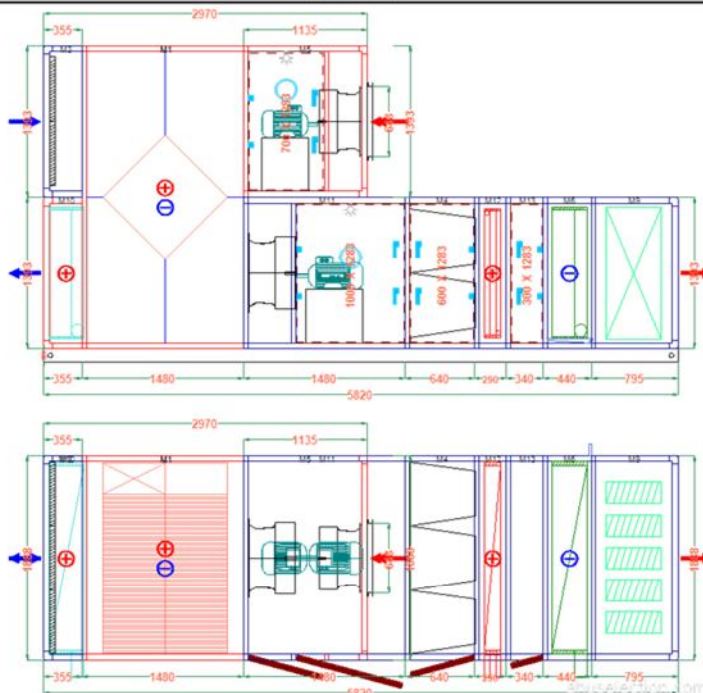

TOP VIEW

GENERAL SPECIFICATIONS

Air Flow	Return Air Flow	Frame	Dimensions cm	
11,772 ft ³ /min	11,772 ft ³ /min	55 Oval Profile	W 188.8 x H 290.6 x L 582	
Air Velocity	Return Air Velocity	Insulation Material	Total Weight	
479 ft/min	479 ft/min	5 cm Polyurethane	1,912 kg	
Coil Air Velocity	Air Density	Outside Sheet Material	Base Height	Roof (Inside)
547 ft/min	1.1943 kg/m ³	0.06 cm Painted Galvanize	12 cm	N/A
Design Outdoor Temp.(W-S)	HRS Capacity (W-S)	Inside Sheet Material	Motor Power	
(10.4°F/90%)-(93.20°F/36.7%) (KONYA)	59.87 kW - 15.69 kW	0.06 cm Painted Galvanize	11 kW / 11 kW	
Total Heating Capacity	Total Cooling Capacity	Total Sensible Capacity	Total Absorbed Power	
244.7 kW	134.3 kW	91.94 kW	16.80 kW	
Specific Fan Power(SFP Total)	ErP Code	Real Unit CAL Class -400 Pa	Real Unit CAL Class +400 Pa	
0.8487 W/(l/s)	NRVU - BVU			

SOUND POWER LEVEL (dB)

Frequency Hz	125	250	500	1000	2000	4000	8000	LwA-tot	
Airborne Sound Power Level	83.0	79.0	79.0	79.0	77.0	75.0	72.0	83.5	dB(A)
Air Outlet Induct Sound Power Level	72.4	60.0	60.8	59.2	59.2	60.8	58.2	66.3	dB(A)
Air Inlet Induct Sound Power Level	78.0	73.0	70.0	68.0	68.0	66.0	63.0	74.5	dB(A)
Return Air Outlet Induct Sound Power Level	83.0	79.0	79.0	79.0	77.0	75.0	72.0	83.5	dB(A)
Return Air Inlet Induct Sound Power Level	81.0	78.0	75.0	73.0	72.0	70.0	67.0	79.0	dB(A)

ACCESSORIES

DRAWING VIEW FROM SELECTION SOFTWARE

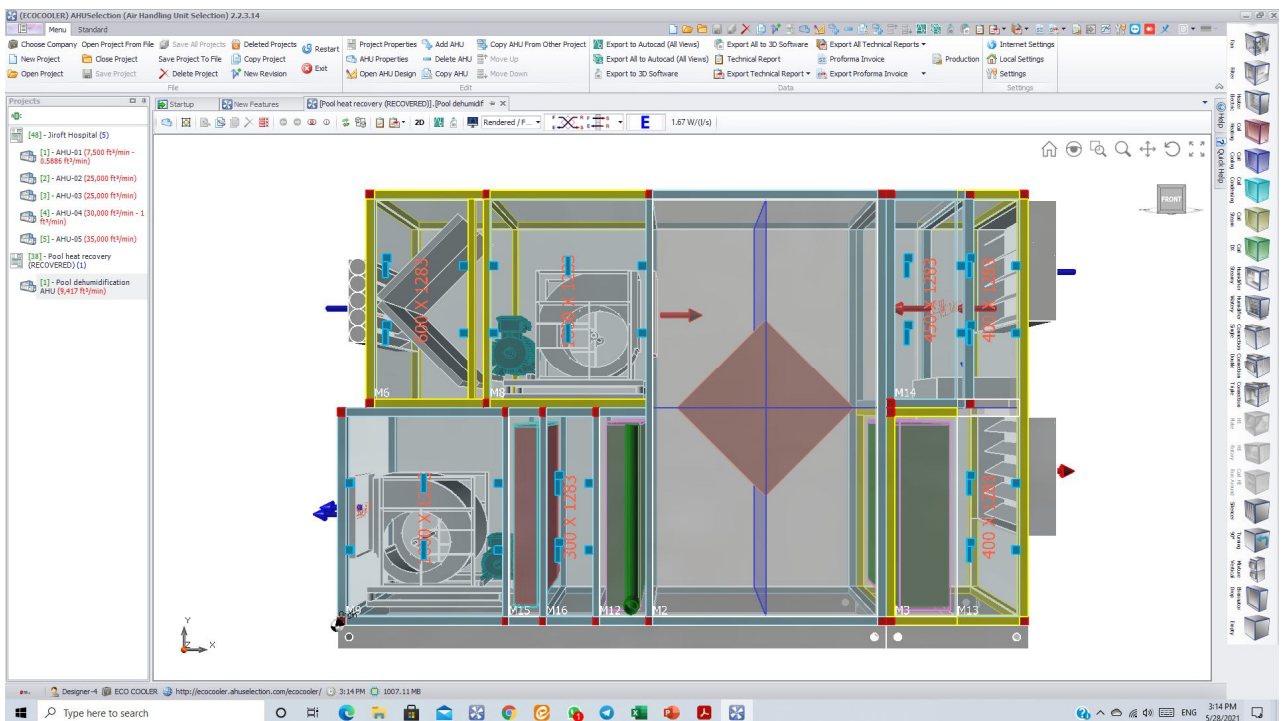
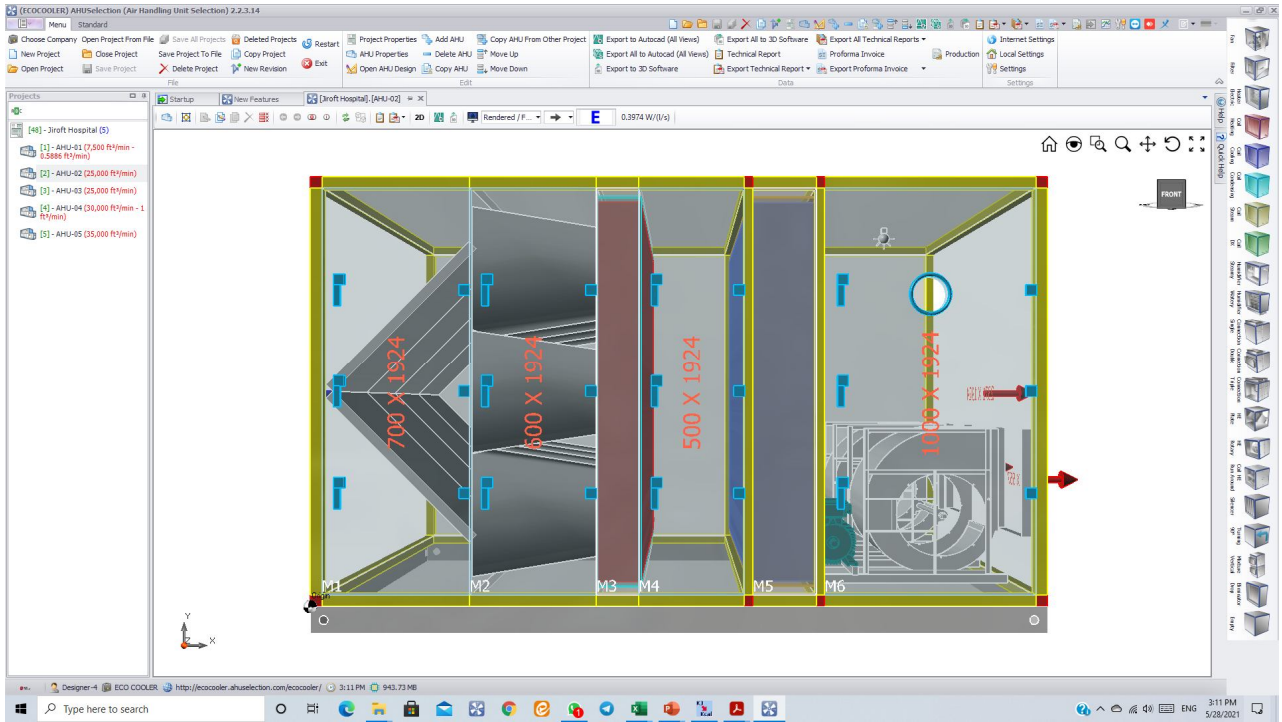

AIR HANDLING UNIT DETAILS

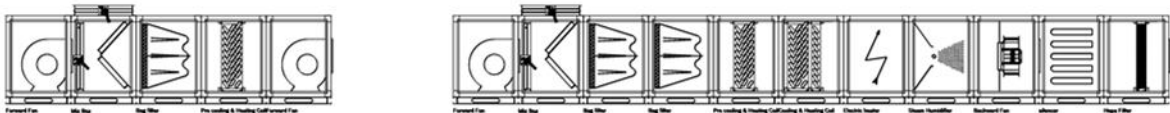
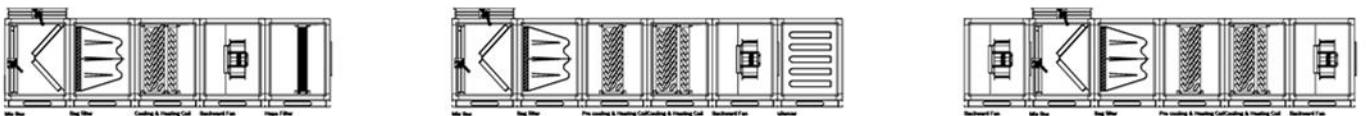
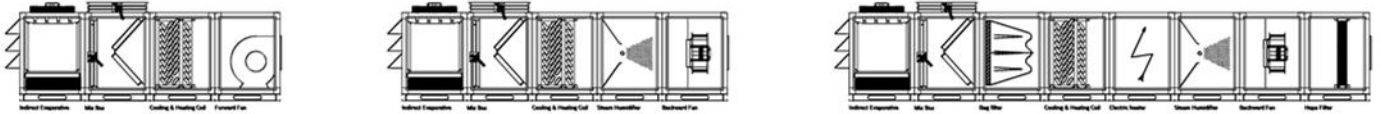
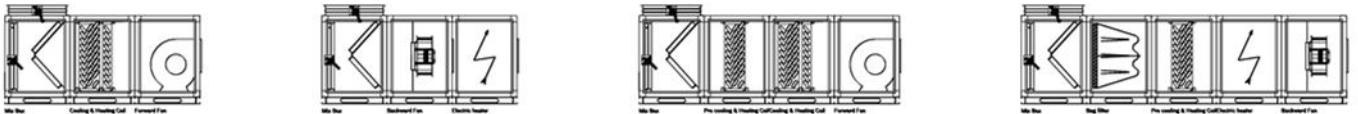

ULTIMATE CASING DESIGN AND CONSTRUCTION

Frame & Panels

THERMAL BREAK SYSTEM 50 WITH "PANEL STOP" PROFILES

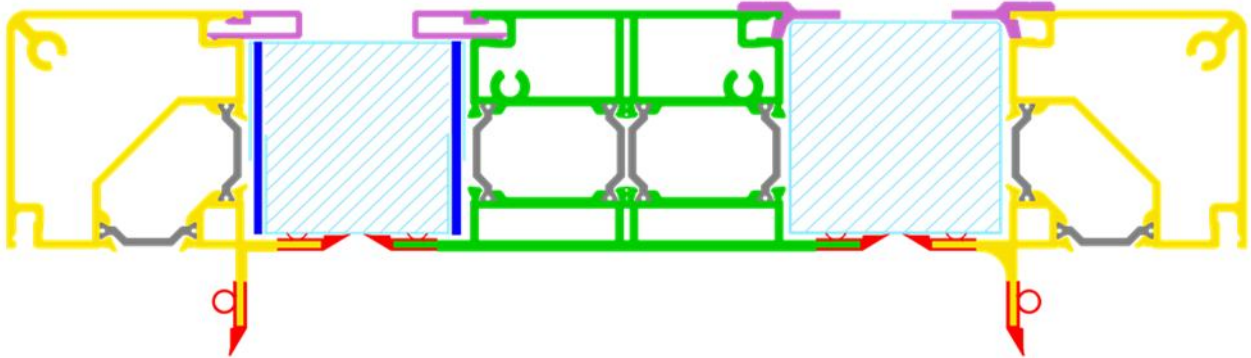

DESCRIPTION:

The new thermal break system guarantees a high thermal insulation thanks to the use of special shaped polyamide bars 25 mm long. One of the peculiarities of this system is the half omega profile that allows the union of two or more units ensuring the thermal bridging between them. This profile thanks to its 40 mm section is very solid. The "panel stop" profiles hold the panels without the use of screws: the system could fit traditional panels made with double steel bended sheet and also sandwich panels that are cheaper and are able to provide a better insulation than traditional ones.

The use of a patented gasket system ensures smooth internal surfaces - so the AHU is easily cleanable - and a perfect air tightness inside the unit. Moreover, the interior of the frame has been designed with a radius shape and nylon rounded corners in order to simplify the maintenance of cleanliness inside the unit. To improve the mechanical and air tightness properties of the frame, the nylon and omega joint corner have special grooves for screws that fasten together the aluminum profile with the plastic components. Furthermore, the screws are hidden by nylon caps that prevent the formation of dust and dirt near the head of the screws.

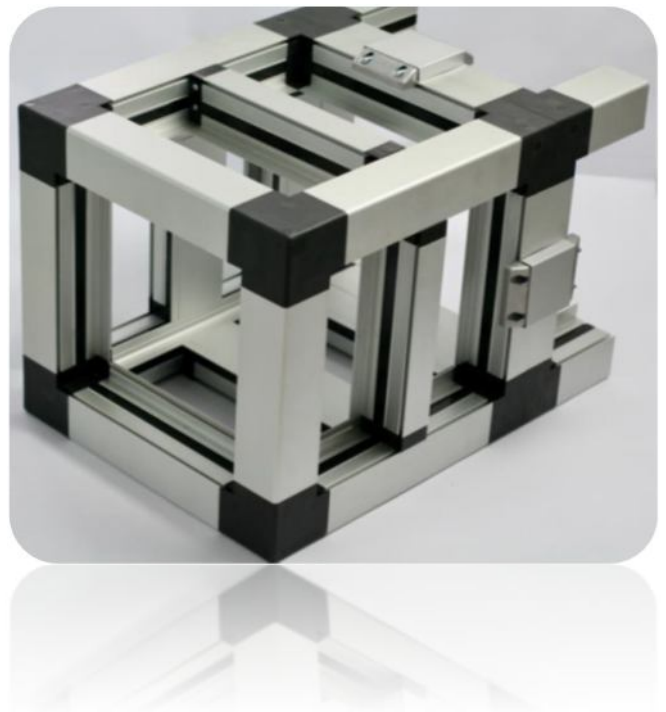

ULTIMATE CASING DESIGN AND CONSTRUCTION

Frame & Panels

THERMAL INSULATION FEATURES
 THERMAL BREAK SYSTEM 60/50 WITH "PANEL STOP" PROFILES

TRIALS AND TESTS MADE WITH SIMULATION SOFTWARE

The peculiarity of the new thermal break system is the level of thermal insulation achieved, both in terms of thermal transmittance and thermal bridging, which classifies it as a T1 - TB1 class according to EN1886.

This result was obtained thanks to a project developed by the Technical department, in close collaboration with R&D office, through the use of specific software to simulate real environmental conditions. The results are shown in the following graphs and tables.

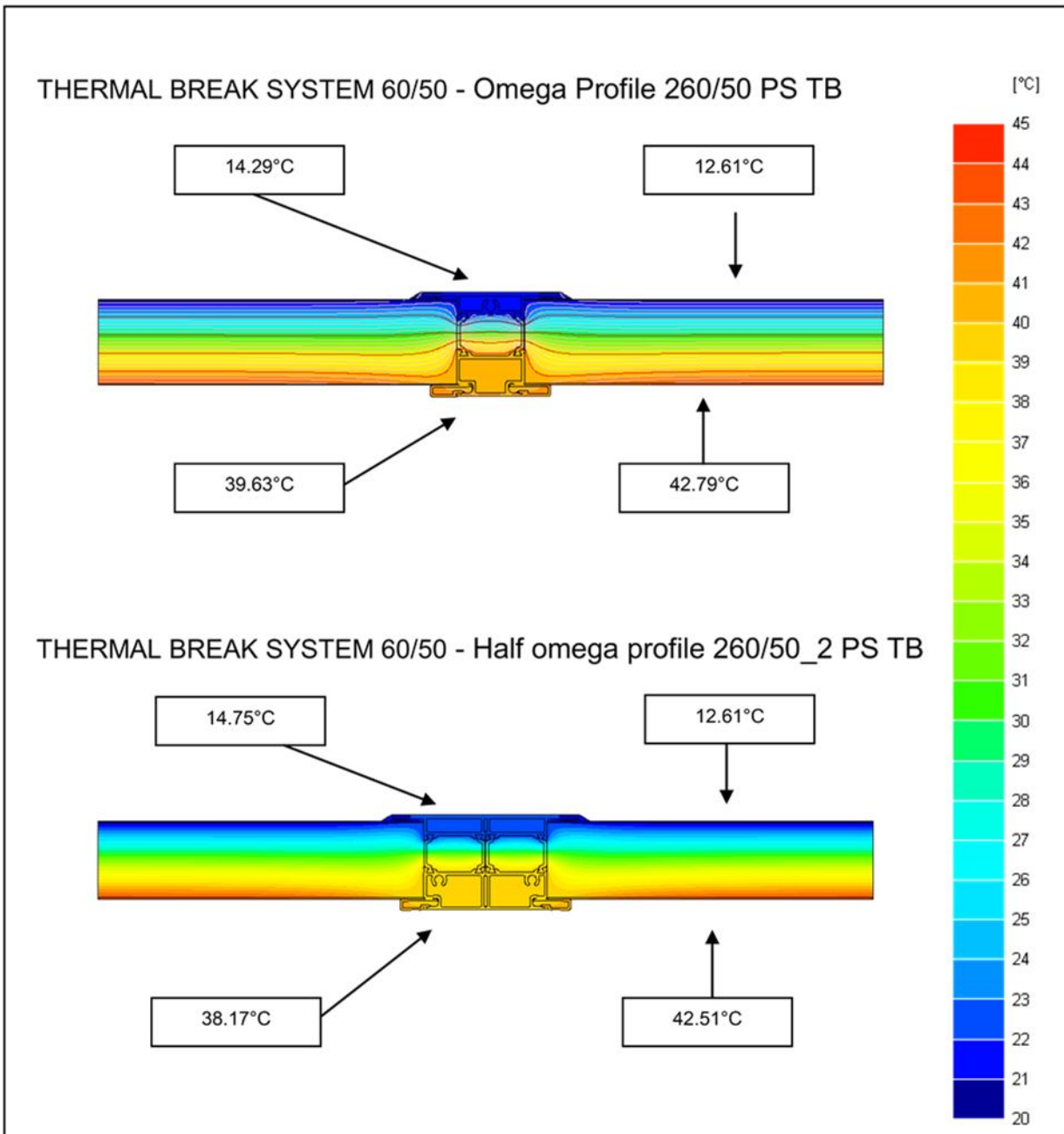

ULTIMATE CASING DESIGN AND CONSTRUCTION

Frame & Panels

Summary table of the results obtained from specific software:

PROFILE TYPE	Ti	t s-max	ta	kb	Thermal Class
System 60/50 – P 160/50 PS TB IR	12	14.52	45	0,92	TB1
System 60/50 – P 260/50 PS TB	12	14.29	45	0,93	TB1
System 60/50 – P 260/50 2 PS TB	12	14.75	45	0,92	TB1

TRIALS AND TESTS CARRIED OUT IN THE LABORATORY

The high thermal insulation class of this thermal brake system has been confirmed by trials and tests performed in the laboratory on an AHU assembled with corner post and omega thermal break profiles, panel stop profiles and patented gasket system. The tables below show the test results that completely meet thermal insulation specifications in compliance with EN 1886.

THERMAL PERFORMANCE	EN 1886	REFERENCE VALUES	RESULT	THERMAL CLASS
THERMAL TRANSMITTANCE	Class T1 Class T2 Class T3 Class T4 Class T5	$U \leq 0,5$ $0,5 < U \leq 1,0$ $1,0 < U \leq 1,4$ $1,4 < U \leq 2,0$ No requirements	0,43	CLASS T 1
THERMAL BRIDGING	Class TB1 Class TB2 Class TB3 Class TB4 Class TB5	$0,75 < k_b < 1,00$ $0,60 < k_b \leq 0,75$ $0,45 < k_b \leq 0,60$ $0,30 < k_b \leq 0,45$ No requirements	0,81	CLASS TB 1

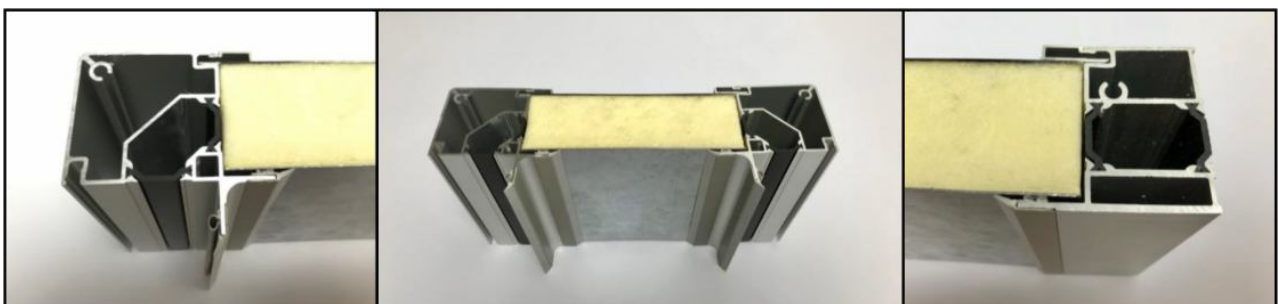

ULTIMATE CASING DESIGN AND CONSTRUCTION

Frame & Panels

AIR TIGHTNESS FEATURES

THERMAL BREAK SYSTEM 60/50 WITH "PANEL STOP" PROFILES

The tests carried out on a "model box" have highlighted the excellent air tightness of the AHU examined. The results obtained are shown in the tables below.

CASING AIR LEAKAGE	- 400 Pa	Class L1 Class L2 Class L3	$\leq 0,15 (l * s^{-1} * m^{-2})$ $\leq 0,44 (l * s^{-1} * m^{-2})$ $\leq 1,32 (l * s^{-1} * m^{-2})$	0,13 = CLASS L1
	+ 700 Pa	Class L1 Class L2 Class L3	$\leq 0,22 (l * s^{-1} * m^{-2})$ $\leq 0,63 (l * s^{-1} * m^{-2})$ $\leq 1,9 (l * s^{-1} * m^{-2})$	0,19 = CLASS L1

MECHANICAL STRENGTH	TEST PRESSURE	EN 1886	REFERENCE VALUES	RESULT
DEFLECTION	-1000 Pa	Class D1 Class D2 Class D3	$\leq 4 \text{ mm} * m^{-1}$ $10 \text{ mm} * m^{-1}$ $>10 \text{ mm} * m^{-1}$	0,51 = CLASS D1

The **panel stop profiles** fix the panel without using screws and **guarantee air tightness** around the perimeter of the frame.

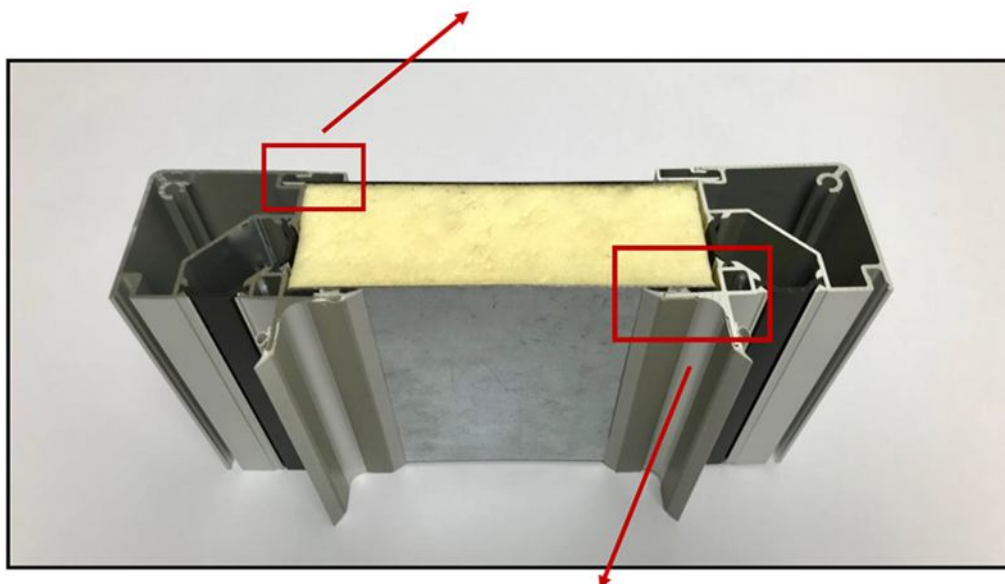

The **gasket** adheres perfectly to the panel and it **creates a smooth inner surface between profiles and panels**.

Access Doors

Handle / Hinges



Explanation

The doors for inspection and internal service can be provided with either outward opening or inward opening for pressurized sections. There are solutions with hinges to allow left or right openings and cam handles to lock and open the door Or even the total removal of the door.

Inspection Window



Explanation

The portholes are double-wall type made of polycarbonate and with sealing gaskets. The fastening system with locking screws that only enter the polycarbonate structure (and therefore not into the sandwich panel) and the continuous internal-external gasket, prevents the formation of condensation and ensures maximum sealing.

MIXING BOX SECTION

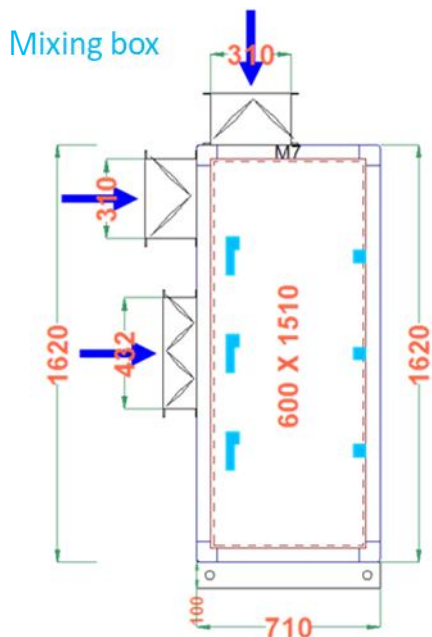

Dampers



Construction

Intake/mixing box is available with damper section based on the project Requirement.

Construction

Aluminum extruded frames (1.8 mm thick), with aero foil design blades. Special gaskets are fixed at the blade edges to avoid the leakage. Gear wheels are made from polypropylene material. Galvanized steel shaft 12mm x 12 mm (square) with aluminum handles for opening and closing the damper. Damper working condition is - 20°C / +80°C, tested and certified by TUV Sud / Munich.

Function

Dampers are used to control or to shut down the air moving in or out of the air handling system. Dampers can be operated manually or can be supplied or fitted with actuators to regulate the flow.

- Airfoil design
- Opposed blade
- Fitted with neoprene gasket in between blades to reduce leakage
- 316L Stainless steel dampers (Optional)

FILTERS

Always taking special care, during the configuration of the unit, to the position of the filters in the airflow, in order to maximize them effectiveness. All filters are mounted on aluminum filter fixing frames, provided with a seal to ensure effective filtration efficiency.

Flat Filters



Explanation

Polyester fiber media panel filters, class G3 supplied as standard. Aluminum washable filters, class G2 will be provided upon customer request.

Bag Filters



Explanation

Synthetic or glass-fiber media bag filters, class starts from M5 to M6, & F7 to F9 fixed in aluminum frame with gaskets to avoid air bypass. Bag Filters are available on two different lengths, 380mm long is standard version and 600 mm long as an optional. Filters having big filtration surface area will give longer life. Filters are fastened by clamping mechanism which secures tightness and simplifies filter replacement procedure.

FILTERS

Always taking special care, during the configuration of the unit, to the position of the filters in the airflow, in order to maximize them effectiveness. All filters are mounted on aluminum filter fixing frames, provided with a seal to ensure effective filtration efficiency.

HEPA Filters



Explanation

HEPA Filters of H13 & H14 class have excellent air cleaning efficiency of their advanced design. A rigid media with Aluminum or PVC Separators provides high efficiency of air filtration at the lowest possible resistance. Rated in accordance with EN1822.

Pressure switch



Optional Components

- Stainless steel filter frame
- Differential pressure switch
- Inclined gauge manometer
- Magnehelic gauge with contact 0-2500 Pa
- Magnehelic gauge without contact – 0 -2500 Pa

FILTER standards

The determination of the filter performance of particulate filters for general room air technology has been described by the industry standard EN779:2012.

EN 779:2012 standard is a certification programme applicable to air filter elements rated and sold as "Medium and Fine Class M5,M6,and F7 to F9"

For coarse filters, the filter effect is evaluated by measuring the initial gravimetric arrestance when challenging the filter with synthetic test dust using ASHRAE-test dust.

For fine filters, the filter effect is evaluated by measuring the efficiency against 0.4 micron DEHS droplets, the classification of classes defined in EN779:2012 is shown in Table 1.

Classification of Coarse, Medium and Fine filters according to EN 799:2012					
Type of filter	EN 779:212 Efficiency Class	Average arrestance with synthetic Dust (Am%)	Average efficiency of 0.4 µm particles (Em%)	Final pressure drop (Pa)	Medium efficiency 0.4 µm (%)
Coarse filters	G1	50≤Am≤65	-	250	
	G2	65≤Am≤80	-	250	
	G3	80≤Am≤90	-	250	
	G4	90≤Am	-	250	
Medium filters	M5	-	40≤Em≤60	450	
	M6	-	60≤Em≤80	450	
Fine filters	F7	-	80≤Em≤90	450	35
	F8	-	90≤Em≤95	450	55
	F9	-	95≤Em	450	70

ISO 16890 is the new global standards for air filter testing and classification and replaces the existing EN779:2012 standard. This new standard represents a major turning point in the evaluation of filter efficiency.

ISO 16890 classification are based on where particles are deposited in the human lung.

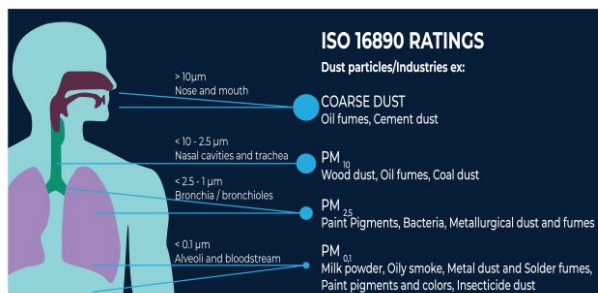

The new international ISO 16890 standard defines four new filter groups based on dust particle size

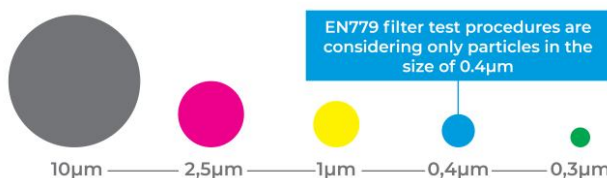

ISO 16890 filter test procedures are considering the range from 0,3µm - 10µm

FILTER standards

The essential feature of the new test is the broad particle size distribution. The new ISO 16890 standard focuses on the filtration efficiency of different sizes of fine particles. It is listed as below 4 different filter classification:

- ISO Coarse (assessment of the separation of ISO A2 dust)
- ISO PM10: particle size $\leq 10 \mu\text{m}$
- ISO PM2.5: particle size $\leq 2.5 \mu\text{m}$
- ISO PM1: particle size $\leq 1 \mu\text{m}$

ISO 16890 is therefore a much more concrete standard on the subject than the theoretical EN779:2012 which used particle of 0.4 micron to measure the effectiveness of filters from M5 to F9. With the new ISO 16890 filter standard, filtration effectiveness are determined based on the different PM1, PM2.5 and PM10 fine particle sizes. The same parameters are used as those deployed by the World Organization (WHO) or the Federal Environmental Agency.

Filter groups according to ISO 16890			
Filter Class	Efficiency range	Particle Size (μm)	Examples for fine dust
ISO ePM1	ePM1,min $\geq 50\%$	$0.3 \mu\text{m} \leq x \leq 1.0 \mu\text{m}$	Ultra fine dust with a diameter of less than $1 \mu\text{m}$: Viruses, Bacteria, nanoparticles, soot (from fossil fuels)
ISO ePM2.5	ePM2.5,min $\geq 50\%$	$0.3 \mu\text{m} \leq x \leq 2.5 \mu\text{m}$	Fine dust with a diameter of less than $2.5 \mu\text{m}$: pollen, rock dust from field cultivation
ISO ePM10	ePM10 $\geq 50\%$	$0.3 \mu\text{m} \leq x \leq 10.0 \mu\text{m}$	Fine dust with a diameter of less than $10 \mu\text{m}$: Bacteria, fungal and molds pores, pollen, toner dust
ISO Coarse	ePM10 $\leq 50\%$	$0.3 \mu\text{m} \leq x \leq 10.0 \mu\text{m}$	Visible coarse dust: sand, hair sand leaves, lint, air born seed lings,etc.

The testing and evaluation procedures of ISO 16890 and EN 779 differ greatly. Therefore use of tables or calculations which claim to convert G1-F9 filter classes into ISO filter groups cannot be recommended. Between EN779 and ISO 16890 there are similarities as below:

Filter Class	ISO 16890-Average Efficiency			
	ePM1	ePM2.5	ePM10	Coarse
EN 779:2012				
G2	-	-	-	30%-50%
G3	-	-	-	55%-75%
G4	-	-	-	80%95%
M5	5%-35%	10%-45%	40%-70%	-
M6	10%-40%	20%-50%	60%80%	-
F7	40%-65%	65%75%	80-90%	-
F8	65%-90%	75%95%	90%100%	-
F9	80%-90%	85%95%	90%-100%	-

FAN SECTION

Rigid Fan Assembly with Standard AHU Components

Fans

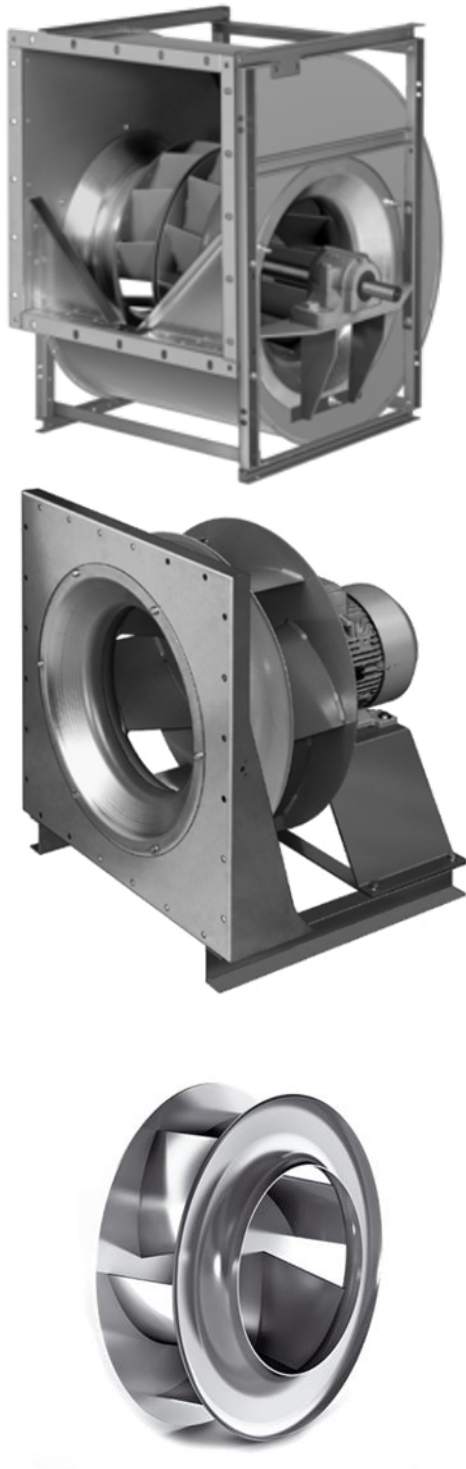

EXPLANATION



- Centrifugal Forward Curved DIDW Fans are manufactured in Galvanized Steel Sheet. The impellers manufactured in galvanized sheet steel statically and dynamically balanced, in accordance with VDI 2060 and ISO 1940/1, grade G 6, 3. Impeller diameters are in series R20 according to DIN 323.
- Shafts are manufactured from high quality steel Centrifugal Backward Curved DIDW/AEROFOIL Fans are manufactured in Galvanized Steel Sheet with Structurally reinforced housing.
- The Impeller is manufactured in Glass reinforced polyamid with Backward Curved and balanced, both statically and dynamically, to an accuracy grade of G = 6,3 in accordance to DIN ISO 1940-1 (VDI 2060).
- Shafts are manufactured from high quality steel, they are precision ground and polished.
- The Plug type Plenum Fan is a Direct Driven Single Inlet Centrifugal Fan without Volute Fan Casing.
- The Impellers are Manufactured in steel, with either backward curved or backward curved airfoil blades and painted finish.
- The Impellers are directly mounted on the Shaft end of Single Speed Motor.



FAN SECTION

Rigid Fan Assembly with Standard AHU Components

Motors



Explanation

- Motors protection is ensured by an enclosed fan cooled type class F insulation to IP55.
- Fans are delivered with the single speed motors.
- Control Box is mounted at the top.
- Optional: Eff1 (IE2) or EFF2 (IE1)

Fan & Motor Assembly

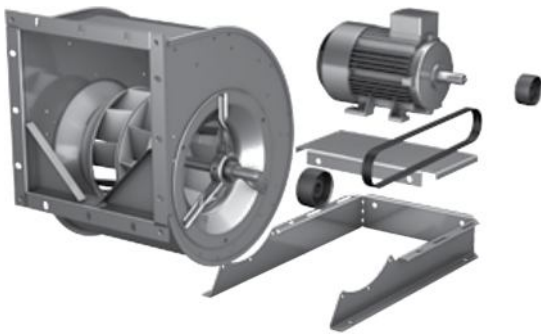

Construction

Entire fan assembly fixed on a separate galvanneal steel frame isolated from the unit structure by rubber anti-vibration mounts (spring as an option). This arrangements guarantee that the AHU does not transmit vibrations to any flat surface on which it is installed

EC Fan



Construction

Realistic performance specifications, as the performance data of the entire fan is continuously measured by means of the components: high performance impeller, GreenTech EC motor and control electronics.

FAN SECTION

Rigid Fan Assembly with Standard AHU Components



Customized Fan Assembly Include:

The customized Fan assembly design includes the following optional features:

- Stand by motors for 24 x 7 operations
- Double fan with double motor
- Spark proof fans
- Inlet guide vanes for VAV control
- Explosion proof motors
- Stainless steel shaft fans
- Extended lubrication fittings
- Fans with drain plug
- Fans with inspection window
- Bulk Head light

Fan Mounting in the Different Orientation:

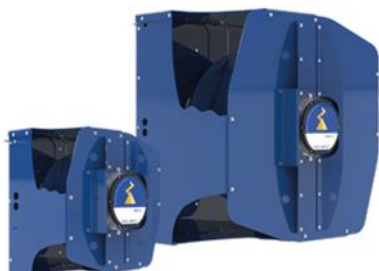

Sizes 315 and 560 mm



Parallel mode of fans

COIL SECTION

Cooling & Heating Coil



Construction

- Computer selected Cooling and heating coils to achieve the optimum thermal and psychometric efficiency with low pressure drops of water and Air.
- Variety of coils including water, direct expansion (R22, R134a, R407C and R410A) and steam coil are available to meet wide range of application requirements.
- Coils comply with AHRI 410 standard.
- Mechanically bonded to aluminum fins, copper tubes with Aluminum End sheets arranged in a stagger form in the direction of air flow.
- Headers are made from copper. Air vents fixed at top of the coil headers. Coil's leak tested at 350 psi air pressure. Cooling coil assembly is mounted on the top of sliding rails for easy with drawl. Entire coil section is covered by stainless steel drain pan with inclined angle design. Drain pans are insulated against condensation with MPT drain connection as a standard.

COIL SECTION

Moisture Eliminator

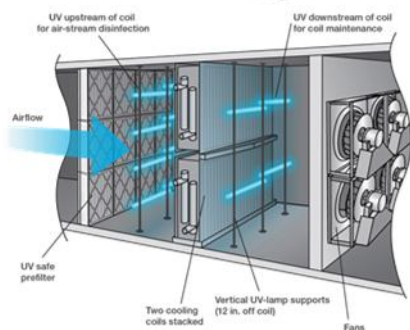

Explanation

Moisture eliminators fixed after the cooling coil when velocity exceeds 2.5 m/s.

Optional Features of Coil:

The customized coil design includes the following optional features.

- Copper or Blue fins.
- Anti corrosive protection coating for fins
- Stainless steel sliding rails.
- Stainless steel coil casing.
- Galvanized (painted) drain pans
- Coil with by-pass dampers.
- U.V. Lights for high level of air purification and deodorization.

Construction

The patented Coil Clean IL UV Systems are designed to prevent and destroy mold and other microbial growth from growing on the evaporator coil and surrounding areas. The benefits include eliminating biological "blow-off" of bacteria, viruses, spores and odors into the building while maintaining a clean coil eliminating the need for conventional coil cleaning. Typically, bio-film coats the coil reducing heat transfer negatively impacting coil efficiencies, the Coil Clean IL maintains a clean coil maximizing system performance enabling the coil to work at optimum efficiency saving energy. Equipped with High-Intensity 19 mm. Quartz UVC Lamps and High-Output Electronic Ballasts paired to Anodized Aluminum Parabolic Reflectors make the Coil Clean Series incredibly effective. By using Anodized Aluminum Parabolic Reflectors, UV Coil Clean Purifiers are able to direct virtually all the UV Energy onto the coil without losing UV on the back-end top and bottom of the UV Lamp. The Reflector also protects plastics and wiring from destructive UV rays. The Coil Clean Parabolic Reflector maximizes UV energy much the same way a flashlight or a car's headlight uses a reflector to direct the UV energy where it is needed most, the coil. Using any other UV Lamp / Emitter will result in losing more than half the UV energy.

LED Status Display

Each Coil Clean IL system includes an LED Status Display incorporated into each Ballast. The 3 color LED notifies the end-user on the status of the UV system and when the UV Lamp needs to be replaced.

Dry Contacts

Each UV Coil Clean IL system includes a pair of Dry Contacts (NO & NC). Dry Contacts make it possible for the Coil Clean ILs to be easily tied to building automation systems.

COIL SECTION

Electric Heater



Construction

Electric heaters are available wide range of capacity (KW) and steps. Electric heaters frame are made of GI. As a standard heater RA provided open type finned heater construction from 80/20 nickel chrome resistance via anti thermal shock, moisture resistant steatite free floating holding ceramics. Electric heater provided in a separate section.

Heat Recovery



Construction

Fins are aluminum as a standard. Upon request, marine aluminum, industrial pre-coated epoxy or hydrophilic fins can be also used. Frame can be manufactured from special aluminum profile covers can be manufactured from galvanized sheet metal or aluminum. Cross-flow heat recovery plate exchangers can be connected in series to increase the efficiency

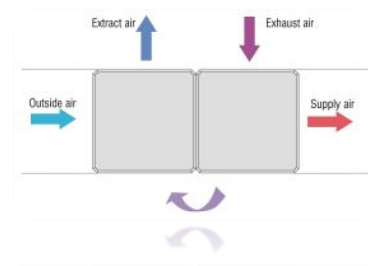

CONTROL EQUIPMENT

To have a great control over running cost, ECO COOLER AHUs are fitted with low noise, high output, Space saving, less weight, long bearing life induction motors. VFD is used to drive the fan at designed RPM to create the required air flow. Fans are driven by motors with V-Belt drive.

VFD Drive Inverter



Construction

ECO COOLER AHUs are compatible to fit with variable-frequency drive (VFD). Controlling Fan volume with a VFD offers the user low noise generation and high energy efficiency when regulating flow to within 80 percentage of design or less. A variable-frequency drive is a system for controlling the rotational speed of an AC electric motor by controlling the frequency of the electrical power supplied to the motor. A variable frequency drive is a specific type of adjustable-speed drive.

Control Valve



Construction

Three-way and Two-way valves can be provided as an optional feature in AHUs. Control valves are factory fitted on the headers of the coil heat exchangers and located inside the casing of AHUs. Control valves are fitted with actuator controls to precisely control the required flow across the coil. Valves are available in Brass up to specific diameter of pipes and the cast iron.

CONTROL EQUIPMENT

Damper Actuator



Construction

Actuators are designed for long lasting, reliable and quiet operation of air control dampers. All actuators feature a universal self centering mounting clamp and anti-rotation strap as well as durable brushless DC motor technology and easy manual positioning. Actuators provide high quality, cost effective solution for all environments, with a complete selection for high humidity, wide temperature extremes and outdoor applications, without requiring costly additional enclosures.

Steam Humidifier



Construction

Air handling units can be equipped with a self-contained humidifier, which is electronically controlled to sense and control the humidity. The steam is generated in a polypropylene cylinder mounted onto the outside of the humidifier section within a special enclosure. A stainless steel distributor suitable in length passes through the unit casing to inject steam in the air stream to reach the needed humidity conditions.



TYPICAL WIRING DIAGRAM

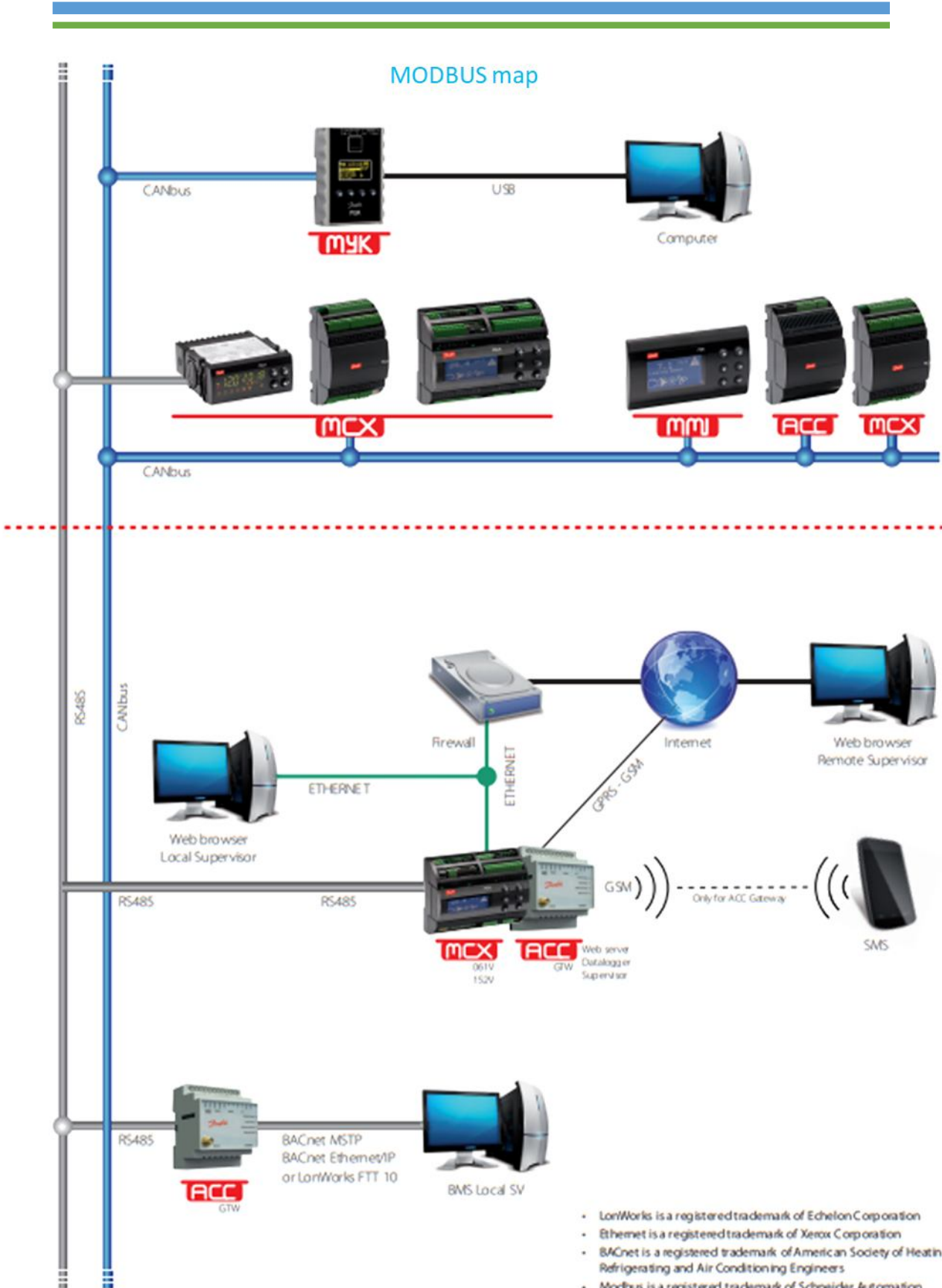

ECO COOLER



. NOTE .

A large rectangular area with rounded corners, outlined in light blue, containing numerous horizontal light blue lines for writing. The lines are evenly spaced and cover the majority of the page below the header.

ECO COOLER
AIR CONDITIONER